



FC
FACTOCOMPONENTS
 INDUSTRIAL SUPPLIES AND MANUFACTURING EQUIPMENT

Magnetostrictive Level Transmitter



FineTek
Innovation · Quality · Sharing

INTRODUCTION

The FineTek magnetostrictive level transmitter identifies the level of liquids and solutions with high precision and reliability.

This versatile sensor is ideal for continuous level measurement of a wide range of liquids. Application ranges from petrochemical industries, marine and shipping to food and beverage production.

The sensor has a loop power supply and provides direct analog or digital output to the user interface.

The FineTek magnetostrictive level sensor has proven itself due to its durability in a wide range of temperatures, pressures and operating conditions as well as its low maintenance nature.

FEATURES

- Absolute positioning output and no calibration required after power failure.
- Stability and reliability.
- Easy installation without calibration & maintenance.
- Prompt response time, high resolution & high accuracy.
- Durable structure, dust-proof, withstands high pressure.
- Oil/water dual level indication.
- The Max. operation temp. is 195°C.
- EG36, 37, 60 adopted loop power structure for wire saving.
- Explosion-proof model available for hazardous environments.
- IP67(Enclosure)/IP69K(Probe).
- Support HART / RS485 and 4~20mA / voltage output.

APPLICATION

- Liquefied natural gas.
- Crude oil, petroleum's and diesels.
- Chemical processing.
- Pharmaceuticals and medication.
- Food and beverages, breweries.
- Dams, water barriers, wastewater treatment.
- Power plants, marine and shipbuilding.
- Tooling or alignment position for processing machines.

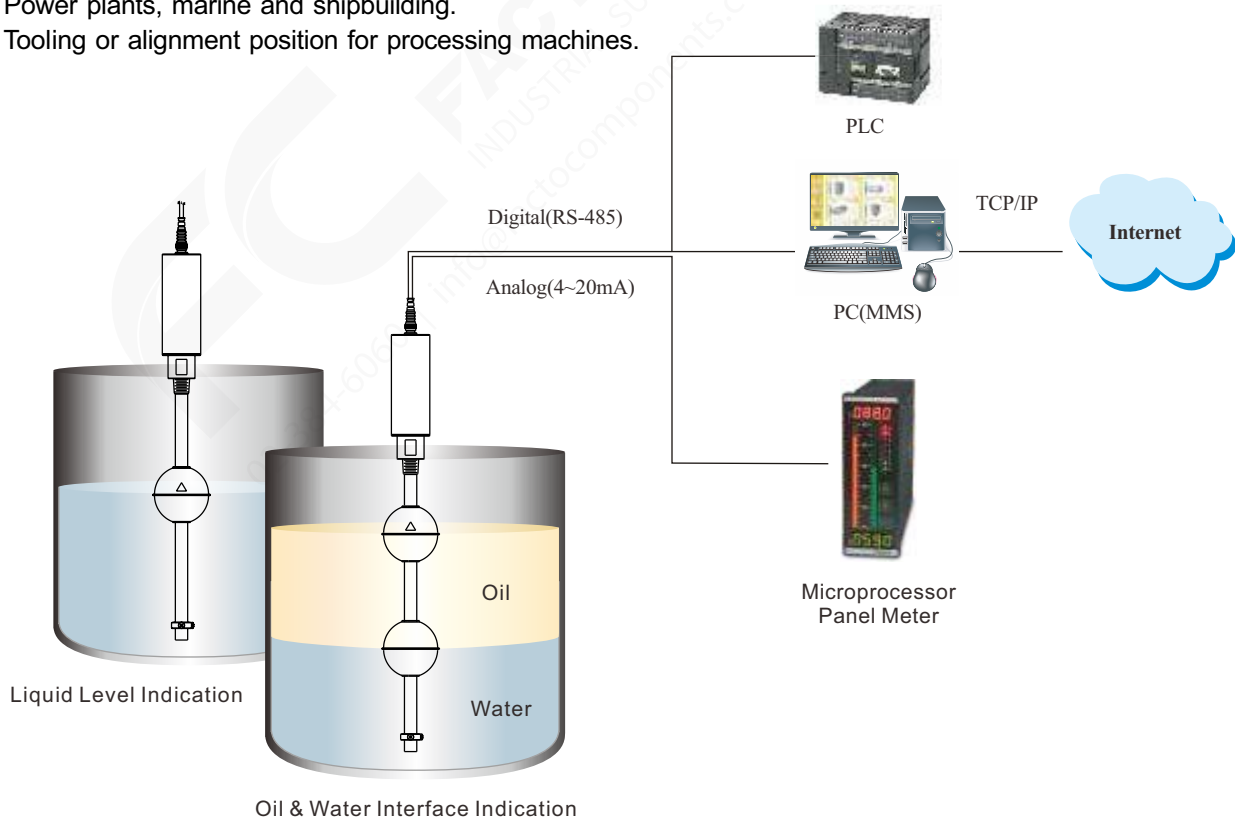

OPERATING PRINCIPLE

The sensor mainly consists of magnetorestrictive wires sealed in a stem/rod and a permanent magnet sealed into a float that can move up and down the stem. Electrical current travels along the wires in the stem creating an axial magnetic field. When the float's and stem's magnetic field intersect, a torsional force is created with different height levels (see right).

The sensor measures the liquid level (D) by calculating the elapsed time between torsional forces. Using velocity and time, distance can be calculated. This action is timely and continuous. A change in float position will be detected promptly via signal output.

CONVERSION FORMULA

The relation of ΔD & 4~20mA output

$$\frac{IX-4}{(20-4)\text{mA}} = \frac{\Delta T - T_X}{\Delta T} = \frac{DX}{\Delta D}$$

$$\Rightarrow IX = \frac{16DX}{\Delta D} + 4\text{mA} \text{ (The relative current)}$$

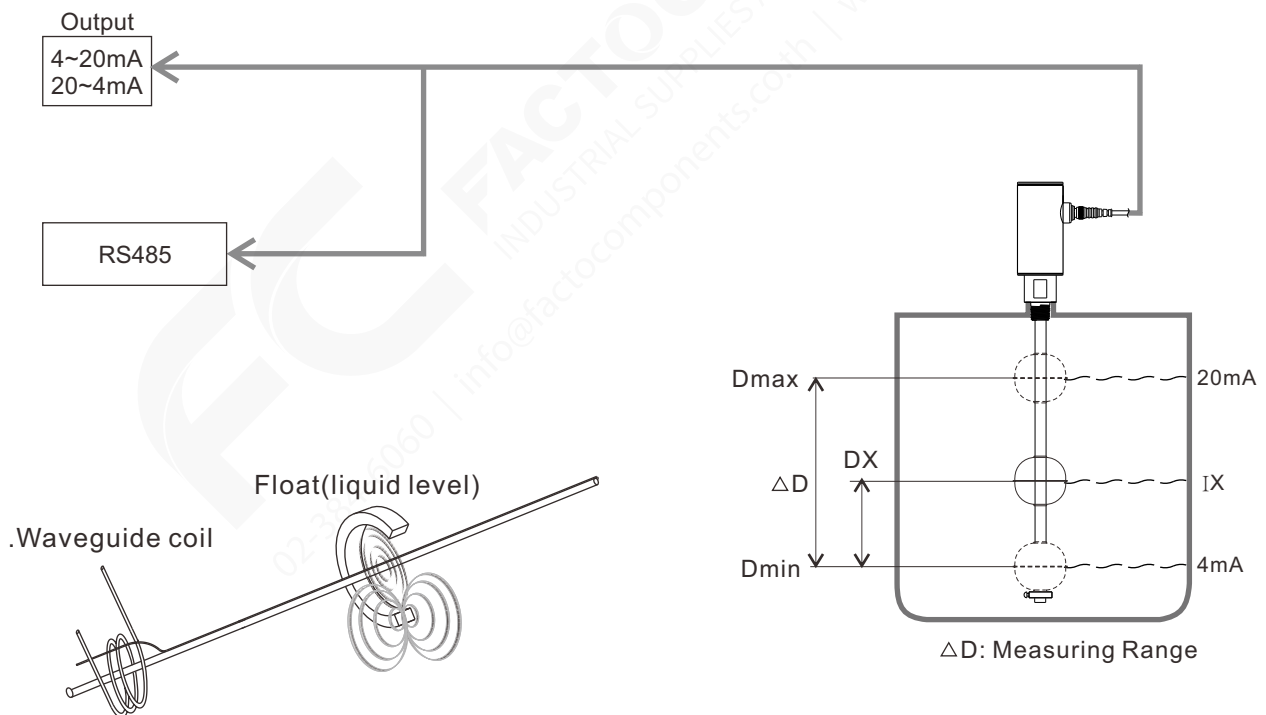
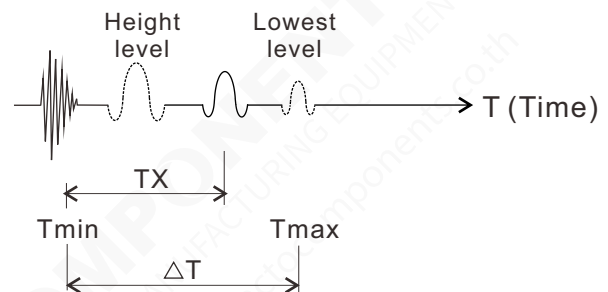

EXPLOSION PROOF MODEL (2 Wire)

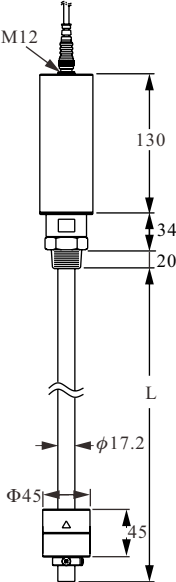
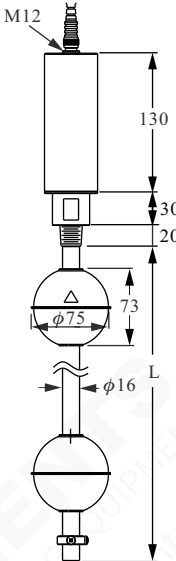

<p>Dimensions (Unit: mm)</p>	 <p style="text-align: center;">NEPSI Ex ia IIB T3-T6 Ga ATEX II 1G Ex ia IIB T3-T6</p>	 <p style="text-align: center;">NEPSI Ex ia IIB T3-T6 Ga ATEX II 1G Ex ia IIB T3-T6</p>
<p>Model No.</p>	<p>EG374 (Anti-Corrosion Model)</p>	<p>EG371 (Single/dual Float Model)</p>
<p>Application</p>	<p>Two-wire loop power output, for acid/alkali corrosion liquids.</p>	<p>Two-wire loop power output, for single/dual level and interface measurement.</p>
<p>Measuring range</p>	<p>50~2000mm</p>	<p>50~5500mm</p>
<p>Non-Linearity</p>	<p>±0.05% F.S. or ±1.0mm (whichever is greater)</p>	<p>±0.05% F.S. or ±1.0mm (whichever is greater)</p>
<p>Repeatability</p>	<p>±0.004% F.S.</p>	<p>±0.004% F.S.</p>
<p>Temp. coefficient</p>	<p>±100 ppm/°C</p>	<p>±100 ppm/°C</p>
<p>Operation pressure</p>	<p>5 BAR(Max.)</p>	<p>30 BAR(Max.)</p>
<p>Ambient temp.</p>	<p>-40°C ~ 85°C</p>	<p>-40°C ~ 85°C</p>
<p>Operation temp.</p>	<p>-20°C ~ 80°C</p>	<p>-40°C ~ 125°C</p>
<p>Temp. accuracy</p>	<p>±1°C</p>	<p>±1°C</p>
<p>Output</p>	<p>4~20mA / 2 Wire</p>	<p>4~20mA / 2 Wire</p>
<p>Max load (Ω)</p>	<p>(VS-18)÷0.02 VS=Supply voltage</p>	<p>(VS-18)÷0.02 VS=Supply voltage</p>
<p>Digital output</p>	<p>RS485 / HART 7.3(option)</p>	<p>RS485 / HART 7.3(option)</p>
<p>Power supply</p>	<p>12~30V(4-wire), 18~30V(2-wire), 18~28V(Exp Llosion proof)</p>	<p>12~30V(4-wire) ,18~30V(2-wire), 18~28V(Exp Llosion proof)</p>
<p>Housing material</p>	<p>SUS304 (SUS316 option)</p>	<p>SUS304 (SUS316 option)</p>
<p>Connection</p>	<p>3/4"PT</p>	<p>1/2"PT</p>
<p>Wetted material</p>	<p>PP</p>	<p>SUS304</p>
<p>Enclosure</p>	<p>IP67 (Enclosure) / IP69K(Probe)</p>	<p>IP67 (Enclosure) / IP69K(Probe)</p>

※ Must equipped with intrinsic safety barrier to form a standard intrinsically safe system (Ex ia), please refer to another catalog / brochure for TXX safety barrier.

EXPLOSION PROOF MODEL (2 Wire)

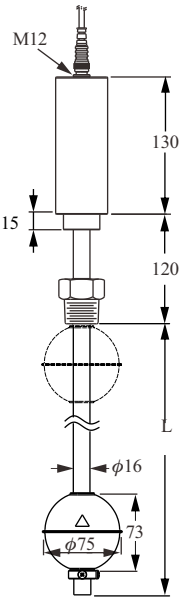
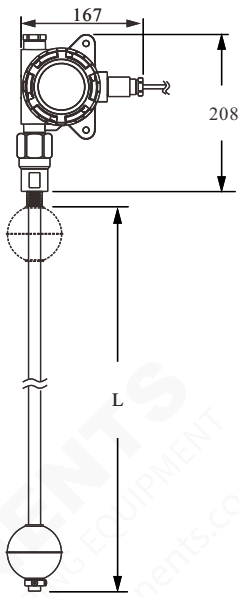

<p>Dimensions (Unit: mm)</p>	 <p>NEPSY Ex ia IIB T3~T6 Ga ATEX Ⓢ II 1G Ex ia IIB T3~T6</p>	 <p>NEPSY Ex ia IIB T3~T6 Ga ATEX Ⓢ II 1G Ex ia IIB T3~T6</p>
<p>Model No.</p>	<p>EG37A (Ex-proof High Temp. Model)</p>	<p>EG36 (Diaplay Model)</p>
<p>Application</p>	<p>Two-wire loop power output, explosion-proof model for hazardous environment.</p>	<p>Two-wire loop power output, explosion-proof model with diaplay for hazardous environment.</p>
<p>Measuring range</p>	<p>50~5500mm</p>	<p>50~5500mm</p>
<p>Non-Linearity</p>	<p>±0.05% F.S. or ±1.0mm (whichever is greater)</p>	<p>50mm~4000mm ±1mm 4000mm~5500mm ±0.025% F.S.</p>
<p>Repeatability</p>	<p>±0.004% F.S.</p>	<p>±0.004% F.S.</p>
<p>Temp. coefficient</p>	<p>±150 ppm/°C</p>	<p>±100 ppm/°C</p>
<p>Operation pressure</p>	<p>30 BAR(Max.)</p>	<p>30 BAR(Max.)</p>
<p>Ambient temp.</p>	<p>-40°C ~ 85°C</p>	<p>-40°C ~ 85°C</p>
<p>Operation temp.</p>	<p>-40°C ~ 195°C</p>	<p>-40°C ~ 125°C</p>
<p>Temp. accuracy</p>	<p>±1°C</p>	<p>±1°C</p>
<p>Output</p>	<p>4~20mA / 2 Wire</p>	<p>4~20mA / 2 Wire</p>
<p>Max load (Ω)</p>	<p>$(VS-18) \div 0.02$ VS=Supply voltage</p>	<p>$(VS-16) \div 0.02$ VS=Supply voltage</p>
<p>Digital output</p>	<p>RS485/HART 7.3(option)</p>	<p>RS485/HART 7.3(option)</p>
<p>Power supply</p>	<p>12~30V(4-wire), 18~30V(2-wire), 18~28V(Exp Losion proof)</p>	<p>12~30V(4-wire) , 16~30V(2-wire), 16~28V(Exp Losion proof)</p>
<p>Housing material</p>	<p>SUS304 (SUS316 option)</p>	<p>Aluminum</p>
<p>Connection</p>	<p>1/2"PT</p>	<p>1/2"PT</p>
<p>Wetted material</p>	<p>SUS304</p>	<p>SUS304</p>
<p>Enclosure</p>	<p>IP67 (Enclosure) / IP69K(Probe)</p>	<p>IP67 (Enclosure) / IP69K(Probe)</p>

※ Must equipped with intrinsic safety barrier to form a standard intrinsically safe system (Ex ia), please refer to another catalog / brochure for TXX safety barrier.

EG50 (4 Wire)

<p>Dimensions (Unit: mm)</p>	
Model No.	EG50
Application	Four wire output
Measuring range	50~1000mm
Linearity	Range of more than 500mm, error $\pm 0.1\%$ F.S Range of 500mm below the error of $\pm 500\mu\text{m}$
Repeatability	$\pm 0.005\%$ F.S.
Temp. coefficient	± 100 ppm/ $^{\circ}\text{C}$
Operation pressure	30 BAR(Max.)
Ambient temp.	$-40^{\circ}\text{C} \sim 85^{\circ}\text{C}$
Operation temp.	$-40^{\circ}\text{C} \sim 125^{\circ}\text{C}$
Temp. accuracy	$\pm 0.5^{\circ}\text{C}$
Output	4~20mA / 20~4mA
Max load (Ω)	$(\text{VS}-18) \div 0.02$ VS=Supply voltage
Digital output	RS485 (Option)
Power supply	18~30V
Housing material	SUS304 (SUS316 Option)
Connection	M18x1.5
Wetted material	SUS304(SUS316 Option)
Enclosure	IP67 (Enclosure) / IP69K (Probe)

EG60 (2 Wire / 4 Wire)

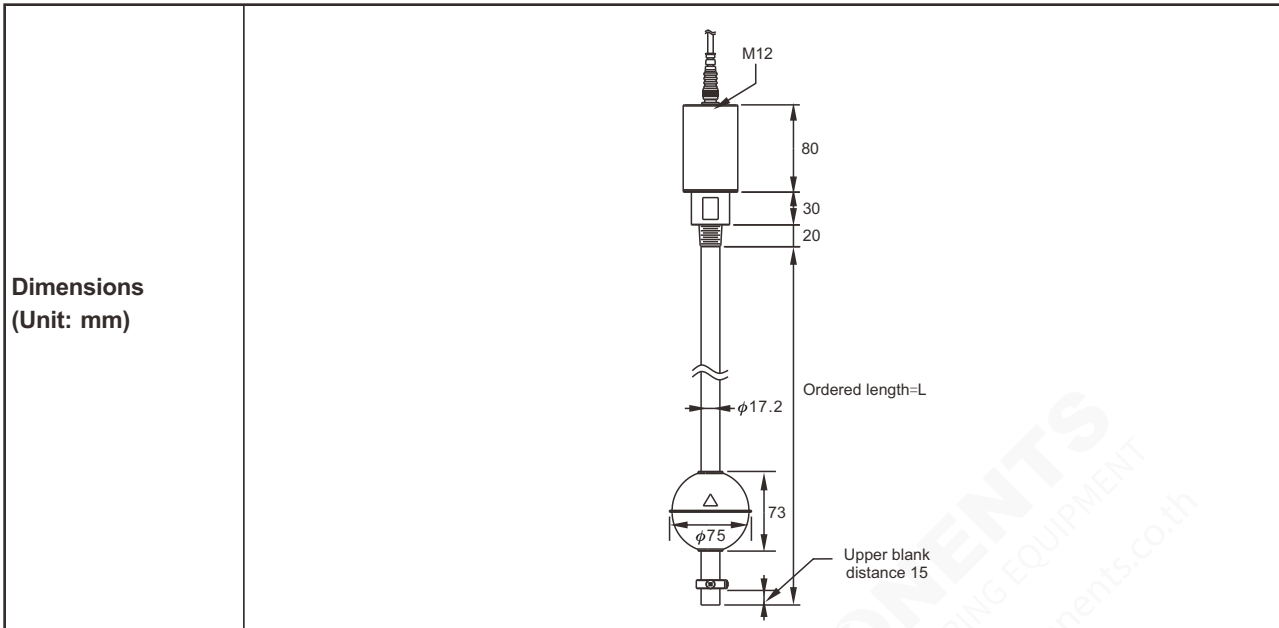

Model No.	EG60 Two wire	EG60 Four wire
Application	Two wire loop Power output, comply with HART demand.	Four wire output
Measuring range	50~5500mm	50~2500mm
Linearity	(50~2000mm), 1mm (2001~5500mm), 0.05%F.S	(50~500mm), 0.1mm (50~500mm), 0.2mm (50~500mm), 0.5mm (500~2500mm), 0.02%F.S (500~2500mm), 0.05%F.S (500~2500mm), 0.1%F.S
Repeatability	± 0.002% F.S.	
Temp. coefficient	± 100 ppm/°C	
Operation pressure	30 BAR(Max.)	
Ambient temp.	-40°C~ 85°C	
Operation temp.	-40°C ~ 125°C (Std. model) , -40~195°C (High temp. model)	
Temp. accuracy	± 0.5°C	
Output	4~20mA/ 20~4mA	0~10V, 10~0V, 0~5V, 5~0V, 4~20mA, 20~4mA
Max load (Ω)	(VS-18)÷0.02 VS=Supply voltage	500W
Digital output	RS485, HART (Option)	RS485 (Option)
Power supply	18~30V	
Housing material	SUS304 (SUS316 Option)	
Connection	1/2"PT	
Wetted material	SUS304	
Enclosure	IP67 (Enclosure) / IP69K (Probe)	

HOUSING OPTIONS

Mapping table of enclosure

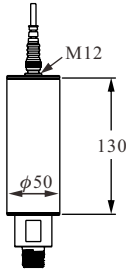
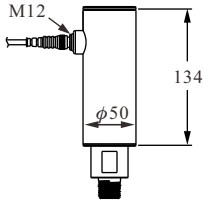
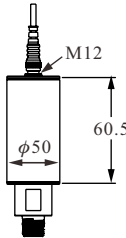
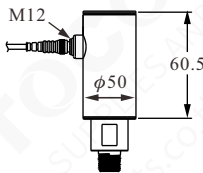
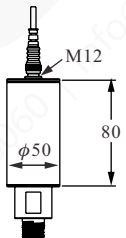
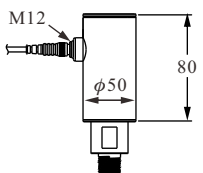
EG37 Explosion-proof (2 wire)	1 Top conduit	2 Side conduit
		
EG50 Four wire	1 Top conduit	2 Side conduit
		
EG60 Two wire & Four wire	1 Top conduit	2 Side conduit
		

※ Standard model cable length is 2m.

FLOAT SPECIFICATIONS

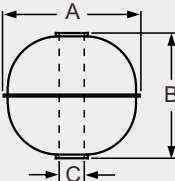
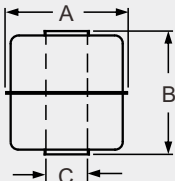
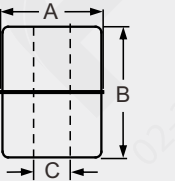
Model	Model Number	Dimensions ($\phi A \times B \times \phi C$ mm)	S.G.	Max. Pressure (kg/cm ²)	Material	Stem Size
	S5	75x73x20.5	E>0.7	30	SUS 304 / 316	$\phi 16$
	S4	52x52x15	E>0.75	30	SUS 316	$\phi 12.7$
	SD	52x52x15	E>0.9	30	SUS 316	$\phi 12.7$
	SE	75x73x20.5	E>0.9	20	SUS 304 / 316	$\phi 16$
	A1	32x69x10.9	E>0.75	10	SUS 316 / 316L	$\phi 8$
	AA	32x69x10.9	E>0.9	10	SUS 316 / 316L	$\phi 8$
	S3	45x55x15	E>0.7	12	SUS 316	$\phi 12.7$
	SC	45x55x15	E>0.9	12	SUS 316	$\phi 12.7$
	F3	45x45x20	E>0.65	5	PP in Grey	$\phi 18$ (coating)
	FC	45x45x20	E>0.9	5	PP in Grey	$\phi 18$ (coating)
	P3	48x45x18.5	E>0.6	5	PP in Black	$\phi 17.2$ (coating)
	PC	48x45x18.5	E>0.9	5	PP in Black	$\phi 17.2$ (coating)
	NB	48x46x15.6	E>0.5	30	NBR in Black	$\phi 12.7$
	ND	48x46x15.6	E>0.9	30	NBR in Black	$\phi 12.7$
	NC	48x46x20	E>0.5	30	NBR in Black	$\phi 16$
	NE	48x46x20	E>0.9	30	NBR in Black	$\phi 16$

※ S.G(E):specific gravity

※ Probe diameter must be smaller then float's hole diameter.

WIRING

When RS485(ModBus)is applied,Loop power only as power.

EG37 / EG60 (2 wire):

1. Single / Double float +RS485

Loop Power 24Vdc ± 10%

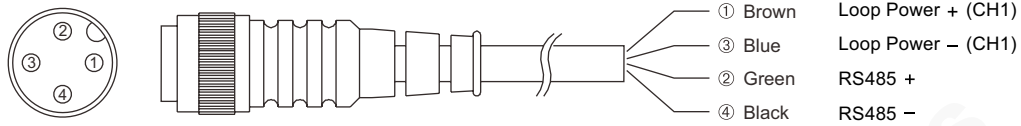

2. Single / Double float +HART

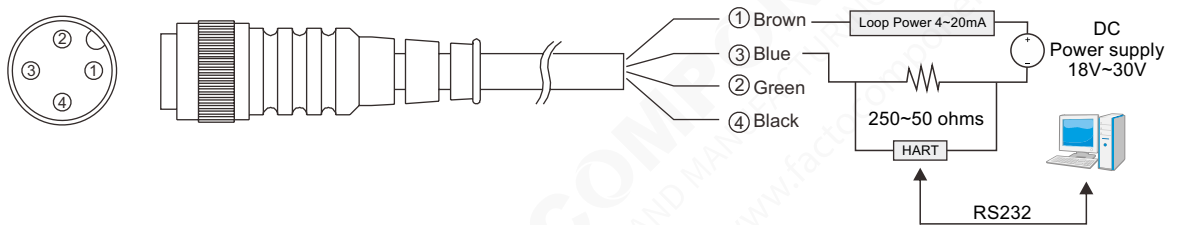

EG36:

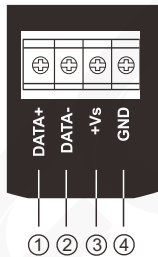

- ① D+: RS485 +
- ② D-: RS485 -
- ③ V+: Loop Power +
- ④ V-: Loop Power -

CUSTOMIZED STEM LENGTHS ARE AVAILABLE

Note the difference between ordered length and actual measurable stem length below.

(2m below) = Actual measurable length (X) = Ordered length (L) - 52mm - 15mm, adopted stem $\phi 12.7$

(2m above) = Actual measurable length (X) = Ordered length (L) - 73mm - 15mm, adopted stem $\phi 16$

(2m below) = Ordered length (L) = Actual measurable length (X) + 52mm - 15mm, adopted stem $\phi 12.7$

(2m above) = Ordered length (L) = Actual measurable length (X) + 73mm - 15mm, adopted stem $\phi 16$

Below 2m, stem $\phi 12.7$

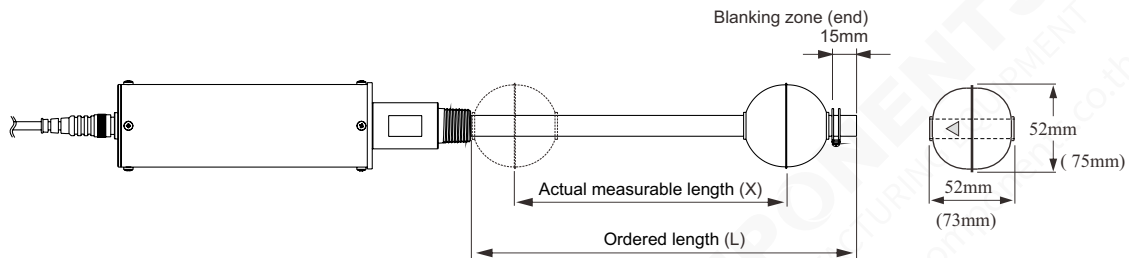

Above 2m, stem $\phi 16$

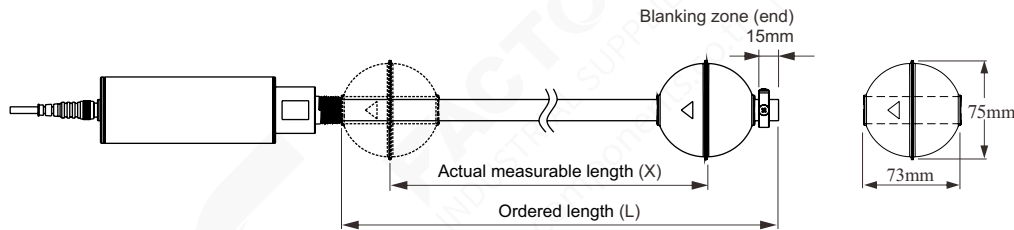

Below 2m, stem $\phi 12.7$, with PP coating to $\phi 17.2$

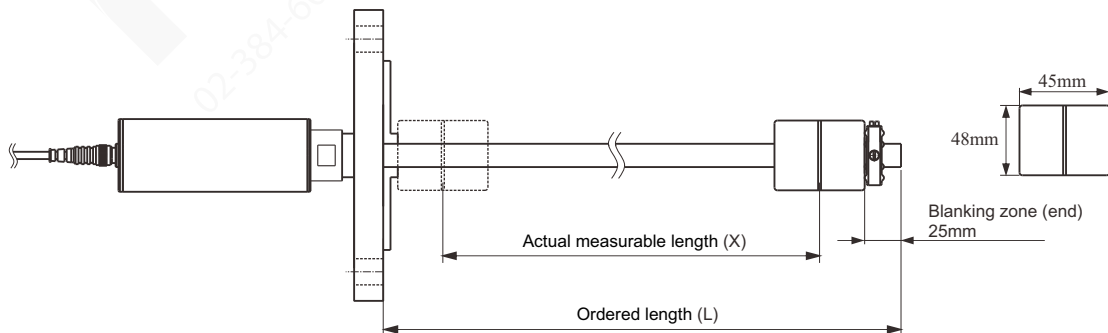

INSTALLATION

1. Loop power 24Vdc \pm 10%
2. The product is calibrated before shipment and should be sufficient to meet user needs.
3. Do not bend the stem, put pressure on it or force it in any manner.
4. For best results, use the included float only.
5. When the mounting hole is large enough, guide the stem and float through the hole to install.
6. If the hole is NOT large enough, remove float, install the stem and assemble float from inside the container.
7. When assembling the float onto the stem, the float's direction mark should face the housing.
8. Ensure the float stopper is fixed firmly.
9. If the stem is bent and can not work, it needs to be returned to the factory for calibration.
11. Bubble wrap/foam packaging is necessary to ensure safety during transportation.
12. Unnecessary opening of housing may affect accuracy.

Removing the float

Step 1:
Loosen the stopper at stem end

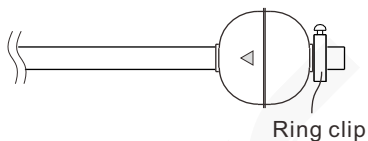

Step 2:
Take off the float

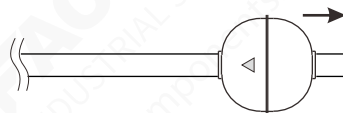

Step 3:
Install the sensor onto the tank,
and tighten the connection

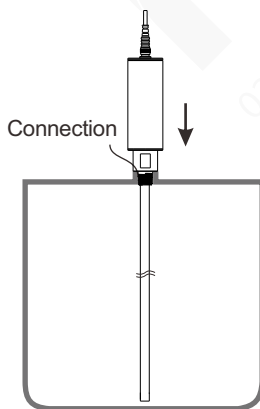

Step 4:
Assemble the float onto the stem
and tighten the connection the
housing. Note the direction of float

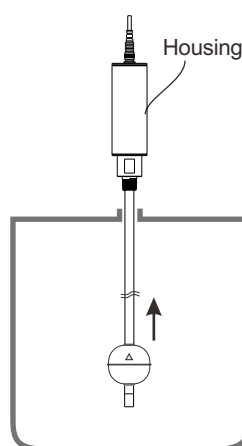

Step 5:
Firmly fasten the stopper

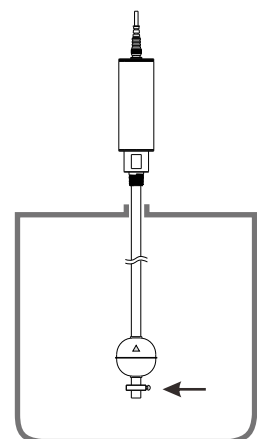

MODEL NUMBER / ORDER CODE COMPARISON TABLE

Model Number	Order Code
EG374 Anti-Corrosion type	EGX1001B-B1
EG371 Ex- Proof type	EGX1001B-A1
EG37A Ex- Proof High temperature type	EGX1021B-A1
EG36 Display type	EGX3001B-A1
EG36 High temperature display type	EGX3021B-A1
EG50	EGX5 □□□□-□□
EG60	EGX6 □□□□-□□

FACTOCOMPONENTS
 INDUSTRIAL SUPPLIES AND MANUFACTURING EQUIPMENT
 02-384-6060 | info@factocomponents.co.th | www.factocomponents.co.th

ORDER INFORMATION

EGX ⒺⒺⒺⒺⒺⒺⒺⒺⒺⒺ-ⒺⒺ

ⒺⒺ **Version**
 1: 132mm (EG37)
 3: Display type (EG36)
 5: EG50

ⒺⒺ **Model**
 00: Standard
 02: Hi-temperature
 03: Sanitary

ⒺⒺ **Certification**
 00: None
 1B: ATEX-Exia
 7B: NEPSI-Exia

ⒺⒺ **Sensor Type**
 A1: Probe type
 B1: Anti-Corrosion probe type

Connection

ⒺⒺ	ⒺⒺ	ⒺⒺ
Flange item	A5: 1/2"	01: PT male
AI : 3A	A7: 3/4"	03: PF male
AK: JIS-FF	A8: 1"	07: NPT male
AN: ANSI-RF	B1: 1-1/2"	15: UNF male
AS: DIN-FF	B2: 2"	40: 5 kg/cm ²
	B4: 2-1/2"	42: 10 kg/cm ²
Thread item	D7: DN20	48: 150 Lbs
AA: JIS	D8: DN25	49: 300 Lbs
AB: ISO	D9: DN32	57: PN10
AC: ANSI	E1: DN40	58: PN16
	E2: DN50	82: (P)1.5 male
	E3: DN65	
	19: M18	

(Next page)



EGX ④⑤⑥⑦⑧ ⑨⑩⑪⑫⑬⑭⑮⑯⑰⑱⑲⑳㉑㉒㉓㉔ ㉕ ㉖ ㉗ ㉘ ㉙ ㉚ ㉛ ㉜ ㉝

㉕ **Digital output 1**

- 0: None
- A: 4~20mA
- B: 20~4mA
- L: 4~20mA x 2 sets
- M: 20~4mA x 2 sets

㉖ **Digital output 2**

- 0: None
- B: RS-485
- C: RS485 (RS485 with temperature x 1pcs)
- E: HART
- F: HART 7.3 with temperature sensor x 1pcs
- ※ Only RS485 can be selected for EG5.

㉗ **Housing**

- A: Top conduit
- B: Side conduit

㉘ **Response time**

- A: 16 Hz (EG36 , EG37)
- C: <1KHz (EG5)

㉙ **Material and surface roughness**

- 0: None
- A: Ra < 0.3
- B: Ra < 0.5
- C: Ra < 0.8

⑩⑪⑫⑬ **Length**

Code	Probe Length
0050~5500	50~5500mm

※ Max. probe length for EG5 is 1000m.



EGX [04] [05] [06] 00 - [09] [10] [11] [12] [13] [14] [15] [16] [17] [18] [19] [20] [21] [22] [23] [24] [25] [26] [27] [28] [29] [30] [31] [32] [33] [34] [35]

④ **Version**

6: EG60

⑤ ⑥ **Model**

00: Standard
 02: Hi-temperature
 03: Sanitary

⑨ ⑩ **Probe type**

A1: Probe type
 B1: Anti-Corrosion probe type

Connection

⑪ ⑫
 Flange item
 AI : 3A
 AK: JIS-FF
 AN: ANSI-RF
 AS: DIN-FF

⑬ ⑭
 A5: 1/2"
 A7: 3/4"
 A8: 1"
 B1: 1-1/2"
 B2: 2"
 B4: 2-1/2"
 D7: DN20
 D8: DN25
 D9: DN32
 E1: DN40
 E2: DN50
 E3: DN65

⑮ ⑯
 00: None
 01: PT male
 03: PF male
 07: NPT male
 40: 5 kg/cm²
 42: 10 kg/cm²
 48: 150 Lbs
 49: 300 Lbs
 57: PN10
 58: PN16

(Next page)

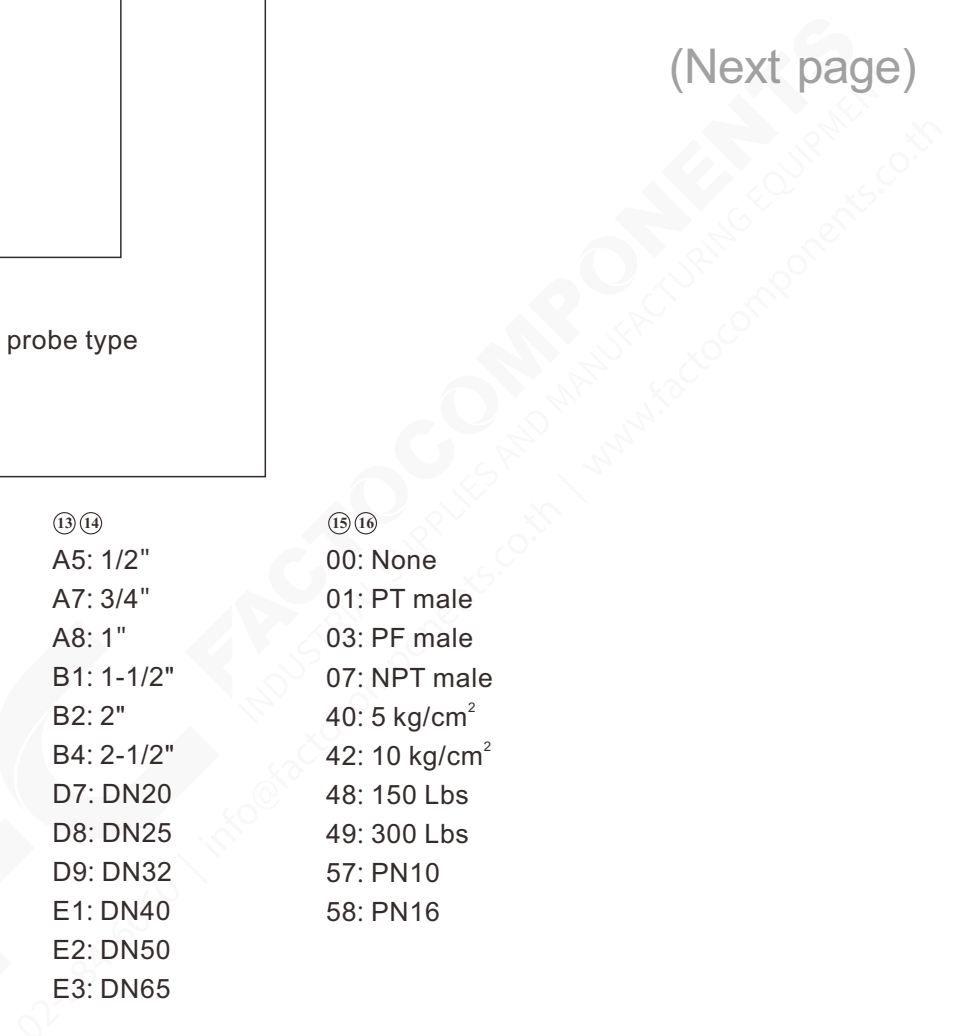

EGX [04][05][06][07][08]-[09][10][11][12][13][14][15][16][17][18][19][20][21][22][23][24][25][26][27][28][29][30][31][32][33][34][35]

17 18 Probe diameter

1F: ϕ 8mm
 2A: ϕ 12.7mm
 2D: ϕ 17.2mm

- ※ PT100 is not available for dia.8 mm probe
- ※ Suggested max. length for dia.8mm probe is less than 1000mm, to prevent risks on installation and transportation.
- ※ Suggested min. dia.17.2mm probe if for more than 2000mm measuring range, to prevent risks on installation and transportation.
- ※ Diameter for PP coated probe is 17.2mm, suggested the measuring range to be less than 2000mm

19 20 Probe material

MA: SUS 304
 MB: SUS 316
 MC: SUS 316L
 18: PP coating

21 22 Float 1

00: None
 S3: 45*55*15(E>0.7) P3: 48*45*18.5(E>0.6)
 SC: 45*55*15(E>0.9) PC: 48*45*18.5(E>0.9)
 S4: 52*52*15(E>0.75) NC: 48*46*20(E>0.5)
 SD: 52*52*15(E>0.9) NE: 48*46*20(E>0.9)
 NB: 48*46*15.6(E>0.5) S5: 75*73*20(E>0.7)
 ND: 48*46*15.6(E>0.9) SE: 75*73*20.5(E>0.9)
 F3: 45*45*20(E>0.65) A1: 32*69*10.9(E>0.75)
 FC: 45*45*20(E>0.9) AA: 32*69*10.9(E>0.9)

- ※ Only "A1", "AA" can be selected for sanitary.

23 24 Float 2

00: None PC: 48*45*18.5(E>0.9)
 SC: 45*55*15(E>0.9) NE: 48*46*20(E>0.9)
 SD: 52*52*15(E>0.9) SE: 75*73*20.5(E>0.9)
 ND: 48*46*15.6(E>0.9) AA: 32*69*10.9(E>0.9)
 FC: 45*45*20(E>0.9)

25 Input

A: 2 wire
 B: 4 wire

(Next page)

EGX 04 05 06 07 08 09 10 11 12 13 14 15 16 17 18 19 20 21 22 23 24 25 26 27 28 29 30 31 32 33 34 35

⑳ **Digital output**

- 0: None
- A: 4~20mA
- B: 20~4mA
- E: 0~5V
- F: 5~0V
- G: 0~10V
- H: 10~0V

㉑ **Analog output**

- 0: None
- B: RS-485
- C: RS485 (RS485 with temperature x 1pcs)
- E: HART
- F: HART 7.3 with temperature sensor x 1pcs

㉒ **Housing**

- A: Top conduit
- B: Side conduit

㉓ **Response time**

- A: 16 Hz
- C: 250Hz

㉔ **Linearity**

- 3: 0.02% F.S
- 7: 0.05% F.S
- 8: 0.1% F.S
- V: 0.1 mm
- W: 0.2 mm
- X: 0.5 mm
- Y: 1 mm

- ※ Only "7" , "Y" can be selected for 2 wire type
- ※ All can be selected except "Y" for 4 wire type
- ※ Refer specification descriptions for more details of options

㉕ **Material and surface roughness**

- 0: None
- A: Ra < 0.3
- B: Ra < 0.5
- C: Ra < 0.8

㉖ ㉗ ㉘ ㉙ **Length**

Code	Probe Length
0050~5500	50~5500mm