



Inline sensor-fitting with paddle wheel for flow measurement

- DN 06...DN 65
- Wide range of materials and type of process connections available to ideally fit to the individual applications and process conditions
- Closed pipe system, sensor inside fitting
- Quarter-turn technology
- Transmitter available for indication, monitoring, transmitting, On/Off control or batch control

Product variants described in the data sheet may differ from the product presentation and description.

Can be combined with

	Type SE30 Transmitter for Inline sensor-fitting	▶
	Type SE32 Transmitter for Inline sensor-fitting	▶
	Type SE35 Transmitter or batch controller for Inline sensor-fitting	▶
	Type SE36 ELEMENT transmitter for Inline sensor fitting	▶
	Type 8611 eCONTROL - Universal controller	▶

Type description

The sensor-fitting Type S030 has a built-in paddle wheel to measure the flow rate and is especially designed for use with neutral, slightly aggressive, solid free liquids.

The compact sensor-fitting (Type S030) must be equipped with a Bürkert transmitter (Type SE30, Type SE30 Ex, Type SE32, Type SE35, Type SE36 or Type 8611) quickly and easily connected together by a bayonet catch. The Bürkert "Inline quarter-turn" technology is a construction ensuring a leakage free operation.

The paddle wheel rotation (permanent magnets included in the blades) is detected contactless by the sensitive element of the transmitter through the sensor-fitting wall. The transmitter can be fitted and removed without opening the pipe or interrupting the running process.



Table of contents

1. General technical data	4
2. Approvals and conformities	6
2.1. General notes.....	6
2.2. Conformity	6
2.3. Standards.....	6
2.4. Pressure Equipment Directive (PED).....	6
Device used on a pipe	6
2.5. Foods and beverages/Hygiene	6
3. Materials	7
3.1. Bürkert resistApp	7
3.2. Material specifications	7
4. Dimensions	8
4.1. Metal sensor-fitting	8
Internal thread connection	8
External thread connection	8
Weld spigot connection	9
Clamp connection.....	10
Flange connection.....	11
4.2. Plastic sensor-fitting	11
True union connection with nut and solvent/fusion socket.....	11
External thread connection	12
Solvent/fusion spigot connection	12
5. Performance specifications	13
5.1. Pressure temperature diagram.....	13
With Inline sensor-fitting Type S030 standard	13
With Inline sensor-fitting Type S030 -HT	13
6. Product installation	14
6.1. Installation notes	14
Flow measurement.....	14
6.2. Selection of the nominal diameter	15
7. Product operation	15
7.1. Measuring principle.....	15
8. Product design and assembly	16
8.1. Product assembly	16
9. Product accessories	16
10. Networking and combination with other Bürkert products	17
11. Ordering information	18
11.1. Bürkert eShop.....	18
11.2. Recommendation regarding product selection.....	18
11.3. Bürkert product filter	18
11.4. Ordering chart.....	19

	Metal sensor-fitting	19
	Plastic sensor-fitting	20
	Stainless steel sensor-fitting (S030-HT variant)	21
11.5.	Ordering chart accessories	21

DTS 1000011766 EN Version: AK Status: RL (released | freigegeben | validé) printed: 27.05.2024



1. General technical data

Note:

In the range of sensor fittings, there are specific ones for the measurement of flow rates at high temperature and pressure. These are the S030-HT models, which can only be used with the SE30 transmitter in the high temperature variant (SE30-HT).

Product properties	
Material	
Make sure the device materials are compatible with the fluid you are using. Further information can be found in chapter “3.1. Bürkert resistApp” on page 7.	
Further information on the materials can be found in chapter “3.2. Material specifications” on page 7.	
Non wetted parts	
Screw	Stainless steel (316L - 1.4404)
Wetted parts	
Body, sensor armature	Stainless steel (316L - 1.4404), brass (CuZn ₃₉ Pb ₂), PVC, PP or PVDF (depending on the sensor fitting variant Type S030)
Axis	Ceramics (Al ₂ O ₃)
Bearing	<ul style="list-style-type: none"> • Ceramics (Al₂O₃) • Iglidur® (only for Type S030-HT variant)
Paddle wheel	<ul style="list-style-type: none"> • PVDF • Stainless steel (316L - 1.4404) (only for Type S030-HT variant) • PP on request
Sensor-fitting body	Stainless steel (316L - 1.4404), brass (CuZn ₃₉ Pb ₂), PVC, PP or PVDF (depending on the sensor fitting variant Type S030)
Seal	FKM or EPDM (depending on the sensor fitting variant Type S030) Further information can be found in chapter “11.5. Ordering chart accessories” on page 21.
Surface quality	For sensor-fitting in stainless steel: <ul style="list-style-type: none"> • inner surface: Ra < 1.6 µm • outer surface: Ra < 3.2 µm
Compatibility	<ul style="list-style-type: none"> • Bürkert flow transmitter Type SE30, SE30 Ex, SE32, SE35, SE36, batch controller SE35 or 8611 Universal controller • Bürkert flow transmitter Type SE30-HT (only for Type S030-HT variant)
Pipe diameter	DN 06...DN 65
Dimensions	Further information can be found in chapter “4. Dimensions” on page 8.
Measuring principle	Paddle wheel
Measuring range	Flow rate: 0.5...1200 l/min (0.13...317 gpm)
Performance data	
Measurement deviation	<ul style="list-style-type: none"> • Teach-In (via a remote transmitter): ± 1 % of the measured value¹⁾ at teach flow rate value • Standard K factor: ± 2.5 % of the measured value¹⁾
Linearity	± 0.5 % of full scale ¹⁾
Repeatability	± 0.4 % of the measured value ¹⁾
Medium data	
Fluid	Clean, neutral or slightly aggressive, solid-free liquids
Fluid temperature	For sensor-fitting in: <ul style="list-style-type: none"> • PVC: 0...+50 °C (+32...+122 °F) • PP: 0...+80 °C (+32...+176 °F) • PVDF, stainless steel or brass: -15...+100 °C (+5...+212 °F) • stainless steel (Type S030-HT variant): -15...+125 °C (+5...+257 °F)
Fluid pressure	For sensor-fitting in: <ul style="list-style-type: none"> • plastic: max. PN 10 • metal: max. PN 16 • stainless steel (Type S030-HT variant): <ul style="list-style-type: none"> – max. PN 40 (for -15...+90 °C (+5...+194 °F) temperature range) – max. PN 25 (for +90...+125 °C (+194...+257 °F) temperature range) Further information can be found in chapter “5.1. Pressure temperature diagram” on page 13.
Viscosity	Max. 300 cSt.
Rate of solid particles	Max. 1 %
Maximum particle size	0.5 mm

Flow velocity	<ul style="list-style-type: none"> • 0.3...10 m/s • 0.5...10 m/s (only for Type S030-HT variant) <p>Further information can be found in chapter “6.2. Selection of the nominal diameter” on page 15.</p>
---------------	---

Process/Pipe connection & communication

Measuring devices connection	Bürkert bayonet catch
Pipe connection	<p>For sensor-fitting in:</p> <ul style="list-style-type: none"> • plastic: true union with nut and solvent/fusion socket, spigot or external thread • metal: internal or external thread, weld ends, clamp or flange • stainless (Type S030-HT variant): internal or external thread, weld ends (clamp or flange on request)

Approvals and conformities

Directives

CE directive	Further information on the CE directive can be found in chapter “2.3. Standards” on page 6.
Pressure equipment directive	Complying with article 4, paragraph 1 of 2014/68/EU directive Further information on the pressure equipment directive can be found in chapter “2.4. Pressure Equipment Directive (PED)” on page 6.
Foods and beverages/Hygiene	FDA declaration of conformity (stainless steel fitting only with EPDM seal) Must be ordered separately. Further information can be found in chapter “11.5. Ordering chart accessories” on page 21.
Materials	<ul style="list-style-type: none"> • Inspection certificate 3.1 (according to EN-ISO 10204) • Certification of conformity for the surface finish (according to DIN4762, DIN4768, ISO/4287/1) Must be ordered separately. Further information can be found in chapter “11.5. Ordering chart accessories” on page 21.
Others	<ul style="list-style-type: none"> • 3 points flow calibration certificate • Test report 2.2 (according to EN-ISO 10204) <p>Must be ordered separately. Further information can be found in chapter “11.5. Ordering chart accessories” on page 21.</p>

Environment and installation

Ambient temperature	<p>Operation and storage: for sensor-fitting in</p> <ul style="list-style-type: none"> • PVC: - 15...+60 °C (+5...+122 °F) • PP: - 15...+80 °C (+5...+176 °F) • PVDF, stainless steel or brass: - 15...+100 °C (+5...+212 °F) <p>The temperature limits also depend on the used transmitter, see the relevant data sheet or operating instructions for more information.</p>
---------------------	---

1.) Under reference conditions i.e. measuring medium = water, ambient and water temperature = +20 °C (+68 °F), observing the minimum the minimum inlet and outlet sections and the appropriate inner diameter of the pipe.

DTS 1000011766 EN Version: AK Status: RL (released | freigegeben | validé) printed: 27.05.2024

2. Approvals and conformities

2.1. General notes

- The approvals and conformities listed below must be stated when making enquiries. This is the only way to ensure that the product complies with all required specifications.
- Not all available variants of the device can be supplied with the below mentioned approvals or conformities.

2.2. Conformity

In accordance with the Declaration of Conformity, the product is compliant with the EU Directives.

2.3. Standards

The applied standards which are used to demonstrate compliance with the EU Directives are listed in the EU-Type Examination Certificate and/or the EU Declaration of Conformity.

2.4. Pressure Equipment Directive (PED)

The device conforms to article 4, paragraph 1 of the Pressure Equipment Directive (PED) 2014/68/EU under the following conditions:

Device used on a pipe

Note:

- The data in the table is independent of the chemical compatibility of the material and the fluid.
- PS = maximum admissible pressure (in bar), DN = nominal diameter of the pipe

Type of fluid	Conditions
Fluid group 1, article 4, paragraph 1.c.i	DN ≤ 25
Fluid group 2, article 4, paragraph 1.c.i	DN ≤ 32 or PS*DN ≤ 1000
Fluid group 1, article 4, paragraph 1.c.ii	DN ≤ 25 or PS*DN ≤ 2000
Fluid group 2, article 4, paragraph 1.c.ii	DN ≤ 200 or PS ≤ 10 or PS*DN ≤ 5000

2.5. Foods and beverages/Hygiene

Note:

The specific sensor fittings (S030-HT) for the measurement of flow rates at high temperature and pressure is not covered by this certificat.

Conformity	Description
FDA	<p>FDA – Code of Federal Regulations (valid for the variable code PL02, PL03)</p> <p>The variants with the body and the sensor armature made of PVDF or stainless steel materials, the paddle wheel made of PVDF material and the seal made of FKM or EPDM materials are compliant in their composition with the Code of Federal Regulations published by the FDA (Food and Drug Administration, USA) according to the manufacturer's declaration.</p>

DTS 1000011766 EN Version: AK Status: RL (released | freigegeben | validé) printed: 27.05.2024

3. Materials

3.1. Bürkert resistApp

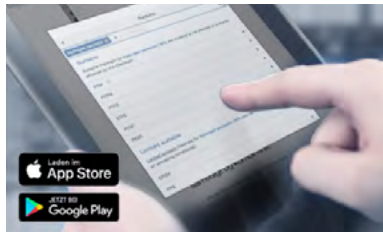

Bürkert resistApp – Chemical resistance chart

You want to ensure the reliability and durability of the materials in your individual application case? Verify your combination of media and materials on our website or in our resistApp.

[Start chemical resistance check](#)

3.2. Material specifications

Note:

The following picture describes the sensor-fitting with a process true union connection with nut and solvent/fusion socket, but this also applies to all variants of process connection.

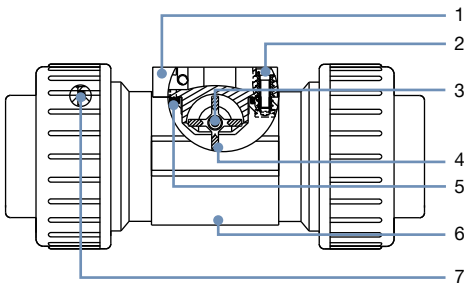

No.	Element	Material
1	Sensor armature	Stainless steel
2	Screws	Stainless steel
3	Axis and bearings	<ul style="list-style-type: none"> • Axis in ceramics (Al₂O₃) • Bearings in: <ul style="list-style-type: none"> – ceramics (Al₂O₃) – Iglidur® (only for Type S030-HT variant)
4	Paddle wheel	<ul style="list-style-type: none"> • PVDF • Stainless steel (only for Type S030-HT variant)
5	Seal	FKM or EPDM (depending on Type S030 variant)
6	Sensor-fitting body	<ul style="list-style-type: none"> • Stainless steel (316L - 1.4404), brass (CuZn₃₉Pb₂), PVC, PP, PVDF (depending on the sensor-fitting variant Type S030) • Stainless steel (316L - 1.4404) (only for Type S030-HT)
7	Seals	FKM or EPDM (depending on the sensor-fitting variant Type S030 and only for true union connection with nut and solvent/fusion socket)

DTS 1000011766 EN Version: AK Status: RL (released | freigegeben | validé) printed: 27.05.2024

4. Dimensions

4.1. Metal sensor-fitting

Internal thread connection

Note:

Dimensions in mm, unless otherwise stated

G, NPT or Rc in stainless steel (316L - 1.4404) or brass (CuZn₃₉Pb₂)

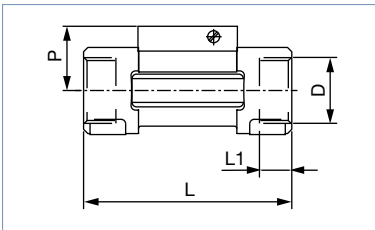

DN	P	L	L1	D [inch]
15	34.5	84.0	16.0	G ½
				NPT ½
				Rc ½
20	32.0	94.0	17.0	G ¾
				NPT ¾
				Rc ¾
25	32.2	104.0	23.5	G 1
				NPT 1
				Rc 1
32	35.8	119.0	23.5	G 1¼
				NPT 1¼
				Rc 1¼
40	39.6	129.0	23.5	G 1½
				NPT 1½
				Rc 1½
50	45.7	148.5	27.5	G 2
				NPT 2
				Rc 2

External thread connection

Note:

Dimensions in mm, unless otherwise stated

G, NPT or Rc in stainless steel (316L - 1.4404) or brass (CuZn₃₉Pb₂)

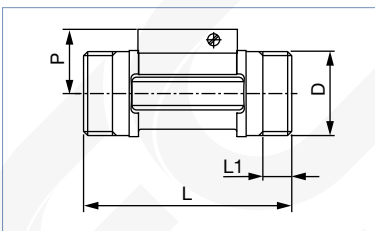

DN	P	L	L1	D [inch]
06	29.5	90.0	14.0	G ½
08	29.5	90.0	14.0	G, NPT or Rc ½
15	34.5	84.0	11.5	G ¾
20	32.0	94.0	13.5	G 1
25	32.2	104.0	14.0	G 1¼
32	35.8	119.0	18.0	G 1½

SMS 1145 in stainless steel (316L - 1.4404)

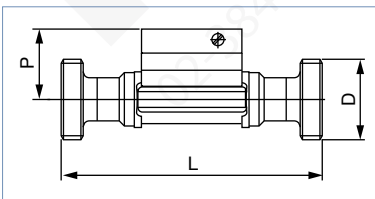

DN	P	L	D
25	32.0	130	Rd 40 x 1/6"
40	35.8	164	Rd 60 x 1/6"
50	39.6	173	Rd 70 x 1/6"

Weld spigot connection

Note:

Dimensions in mm, unless otherwise stated

EN ISO 1127/ISO 4200/DIN 11866 series B, SMS 3008, BS 4825-1/ASME BPE/DIN 11866 series C or DIN 11850 series 2/DIN 11866 series A/ DIN EN 10357 series A in stainless steel (316L - 1.4404)

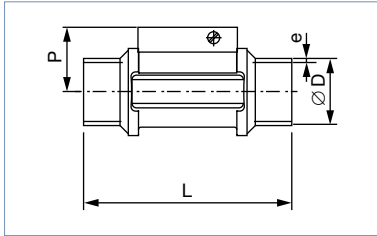

DN	P	Standard	L	ØD	e
08	-	EN ISO 1127/ISO 4200/DIN 11866 series B	-	-	-
	-	SMS 3008	-	-	-
	-	ASME BPE/DIN 11866 series C	-	-	-
	29.5	DIN 11850 series 2/DIN 11866 series A/ DIN EN 10357 series A	96.0	13.00	1.50
15	34.5	EN ISO 1127/ISO 4200/DIN 11866 series B	84.0	21.30	1.60
	-	SMS 3008	-	-	-
	-	ASME BPE/DIN 11866 series C	-	-	-
	34.5	DIN 11850 series 2/DIN 11866 series A/ DIN EN 10357 series A	84.0	19.0	1.50
20	32.0	EN ISO 1127/ISO 4200/DIN 11866 series B	94.0	26.9	1.60
	-	SMS 3008	-	-	-
	34.5	ASME BPE/DIN 11866 series C	84.0	19.05	1.65
	34.5	DIN 11850 series 2/DIN 11866 series A/ DIN EN 10357 series A	84.0	23.00	1.50
25	32.2	EN ISO 1127/ISO 4200/DIN 11866 series B	104.0	33.70	2.00
	32.0	SMS 3008	94.0	25.00	1.20
	32.0	BS 4825-1/ASME BPE/DIN 11866 series C	94.0	25.40	1.65
	32.0	DIN 11850 series 2/DIN 11866 series A/ DIN EN 10357 series A	94.0	29.00	1.50
32	35.8	EN ISO 1127/ISO 4200/DIN 11866 series B	119.0	42.40	2.00
	-	SMS 3008	-	-	-
	32.2	BS 4825-1/ASME BPE/DIN 11866 series C	104.0	32.00	1.65
	32.2	DIN 11850 series 2/DIN 11866 series A/ DIN EN 10357 series A	104.0	35.00	1.50
40	39.6	EN ISO 1127/ISO 4200/DIN 11866 series B	129.0	48.30	2.00
	35.8	SMS 3008	119.0	38.00	1.20
	35.8	BS 4825-1/ASME BPE/DIN 11866 series C	119.0	38.10	1.65
	35.8	DIN 11850 series 2/DIN 11866 series A/ DIN EN 10357 series A	119.0	41.00	1.50
50	45.7	EN ISO 1127/ISO 4200/DIN 11866 series B	148.5	60.30	2.60
	39.6	SMS 3008	128.0	51.00	1.20
	39.6	BS 4825-1/ASME BPE/DIN 11866 series C	128.0	50.80	1.65
	39.6	DIN 11850 series 2/DIN 11866 series A/ DIN EN 10357 series A	128.0	53.00	1.50
65	-	EN ISO 1127/ISO 4200/DIN 11866 series B	-	-	-
	45.7	SMS 3008	147.0	63.50	1.60
	45.7	BS 4825-1/ASME BPE/DIN 11866 series C	147.0	63.50	1.65
	-	DIN 11850 series 2/DIN 11866 series A/ DIN EN 10357 series A	-	-	-

DTS 1000011766 EN Version: AK Status: RL (released | freigegeben | validé) printed: 27.05.2024

Clamp connection

Note:

Dimensions in mm, unless otherwise stated

DIN 32676 series B, SMS 3017^{1.)}, BS 4825-3/ASME BPE^{1.)} or DIN 32676 series A in stainless steel (316L - 1.4404)

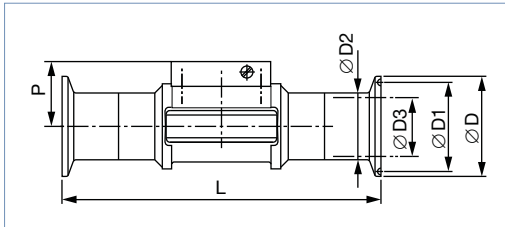

DN	P	Standard	L	ØD	ØD1	ØD2	ØD3
08	-	DIN 32676 series B ^{2.)}	-	-	-	-	-
	-	SMS 3017	-	-	-	-	-
	-	ASME BPE	-	-	-	-	-
	29.5	DIN 32676 series A	125	34.0	27.5	13.00	10.00
15	34.5	DIN 32676 series B ^{2.)}	130	34.0	27.5	21.30	18.10
	-	SMS 3017	-	-	-	-	-
	-	ASME BPE	-	-	-	-	-
	29.5	DIN 32676 series A	119	34.0	27.5	19.00	16.00
20	32.0	DIN 32676 series B	150	50.5	43.5	26.90	23.70
	-	SMS 3017	-	-	-	-	-
	34.5	ASME BPE	119	25.0	19.6	19.05	15.75
	34.5	DIN 32676 series A	119	34.0	27.5	23.00	20.00
25	32.2	DIN 32676 series B	160	50.5	43.5	33.70	29.70
	32.0	SMS 3017	129	50.5	43.5	25.00	22.60
	32.0	BS 4825-3/ASME BPE	129	50.5	43.5	25.40	22.10
	32.0	DIN 32676 series A	136	50.5	43.5	29.00	26.00
32	35.8	DIN 32676 series B	180	50.5	43.5	42.40	38.40
	-	SMS 3017	-	-	-	-	-
	-	BS 4825-3/ASME BPE	-	-	-	-	-
	-	DIN 32676 series A	-	-	-	-	-
40	39.6	DIN 32676 series B	200	64.0	56.5	48.30	44.30
	35.8	SMS 3017	161	50.5	43.5	38.00	35.60
	35.8	BS 4825-3/ASME BPE	161	50.5	43.5	38.10	34.80
	35.8	DIN 32676 series A	161	50.5	43.5	41.00	38.00
50	45.7	DIN 32676 series B	230	77.5	70.5	60.30	55.10
	39.6	SMS 3017	192	64.0	56.5	51.00	48.60
	39.6	BS 4825-3/ASME BPE	192	64.0	56.5	50.80	47.50
	39.6	DIN 32676 series A	170	64.0	56.5	53.00	50.00
65	-	DIN 32676 series B	-	-	-	-	-
	45.7	SMS 3017	216	77.5	70.5	63.50	60.3
	45.7	BS 4825-3/ASME BPE	216	77.5	70.5	63.50	60.2
	-	DIN 32676 series A	-	-	-	-	-

1.) Available with internal surface finish Ra <0.8 µm

2.) Similar to DIN 32676 series B, but with 34.0 mm clamp connection

Flange connection

Note:

Dimensions in mm, unless otherwise stated

EN1092-1/B1/PN 16, ANSI B16-5 or JIS 10 K in stainless steel (316L - 1.4404)

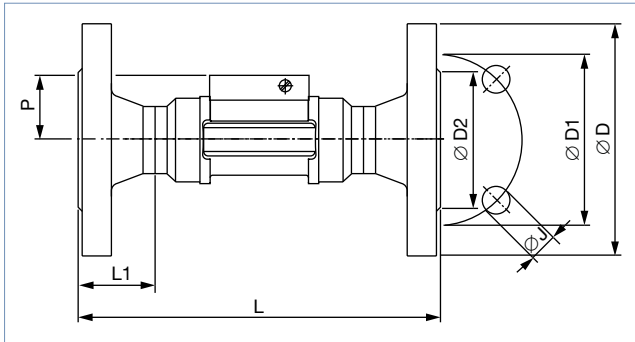

DN	P	Standard	L	L1	ØD	ØD1	ØD2	ØJ
15	34.5	EN	130	23.5	95.0	65.0	45.0	4 × 14.0
		ANSI	130		89.0	60.3	34.9	4 × 15.8
		JIS	152		95.0	70.0	51.0	4 × 15.0
20	32.0	EN	150	28.5	105.0	75.0	58.0	4 × 14.0
		ANSI	150		99.0	69.8	42.9	4 × 15.8
		JIS	178		100.0	75.0	56.0	4 × 15.0
25	32.2	EN	160	28.5	115.0	85.0	68.0	4 × 14.0
		ANSI	160		108.0	79.4	50.8	4 × 15.8
		JIS	216		125.0	90.0	67.0	4 × 19.0
32	35.8	EN	180	31.0	140.0	100.0	78.0	4 × 18.0
		ANSI	180		117.0	88.9	63.5	4 × 15.8
		JIS	229		135.0	100.0	76.0	4 × 19.0
40	39.6	EN	200	36.0	150.0	110.0	88.0	4 × 18.0
		ANSI	200		127.0	98.4	73.0	4 × 15.8
		JIS	241		140.0	105.0	81.0	4 × 19.0
50	45.7	EN	230	41.0	165.0	125.0	102.0	4 × 18.0
		ANSI	230		152.0	120.6	92.1	4 × 19.0
		JIS	267		155.0	120.0	96.0	4 × 19.0

DTS 1000011766 EN Version: AK Status: RL (released | freigegeben | validé) printed: 27.05.2024

4.2. Plastic sensor-fitting

True union connection with nut and solvent/fusion socket

Note:

Dimensions in mm, unless otherwise stated

DIN 8063, ASTM D 1785/76 or JIS K in PVC DIN 16962 in PP or ISO 10931 in PVDF

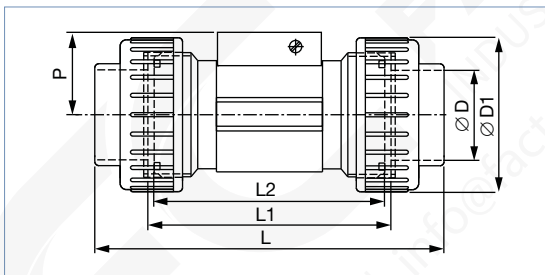

DN	P	Standard	L	L1	L2	ØD	ØD1
08 ^{1.)}	29.5	DIN/ISO	122.0	92	90	12.00	-
		ASTM	-				
		JIS	-				
15	34.5	DIN/ISO	128.0	96	90	20.00	43
		ASTM	130.0				
		JIS	129.0				
20	32.0	DIN/ISO	144.0	106	100	25.00	53
		ASTM	145.6				
		JIS	145.0				
25	32.2	DIN/ISO	160.0	116	110	32.00	60
		ASTM	161.4				
		JIS	161.0				
32	35.8	DIN/ISO	168.0	116	110	40.00	74
		ASTM	170.0				
		JIS	169.0				
40	39.6	DIN/ISO	188.0	127	120	50.00	83
		ASTM	190.2				
		JIS	190.0				
50	45.7	DIN/ISO	212.0	136	130	63.00	103
		ASTM	213.6				
		JIS	213.0				

1.) Only available in PVC

External thread connection

Note:

Dimensions in mm, unless otherwise stated

G, NPT or Rc in PVC (only DN 06 and DN 08) or PVDF (only DN 08)

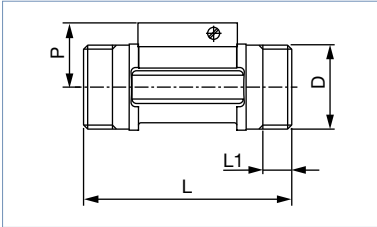

DN	P	L	L1	D
				[inch]
06	29.5	90.0	14.0	G ½
08	29.5	90.0	14.0	G, NPT or Rc ½

Solvent/fusion spigot connection

Note:

Dimensions in mm, unless otherwise stated

DIN 8063 in PVC, DIN 16962 in PP or ISO 10931 in PVDF

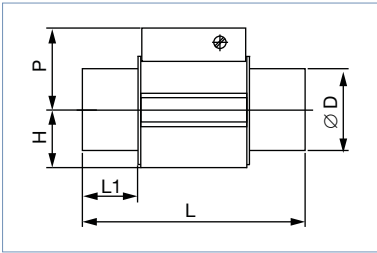

DN	P	Standard	H	L	L1	ØD
15	34.5	DIN 8063	17.5	90	16.5	20
		DIN 16962		85	14.0	
		DIN 10931		85	14.0	
20	32.0	DIN 8063	17.5	100	20.0	25
		DIN 16962		92	16.0	
		DIN 10931		92	16.0	
25	32.2	DIN 8063	21.5	110	23.0	32
		DIN 16962		95	18.0	
		DIN 10931		95	18.0	
32	35.8	DIN 8063	27.5	110	27.5	40
		DIN 16962		100	20.0	
		DIN 10931		100	20.0	
40	39.6	DIN 8063	31.5	120	30.0	50
		DIN 16962		106	23.0	
		DIN 10931		106	23.0	
50	45.7	DIN 8063	39.5	130	37.0	63
		DIN 16962		110	27.0	
		DIN 10931		110	27.0	

DTS 1000011766 EN Version: AK Status: RL (released | freigegeben | validé) printed: 27.05.2024

5. Performance specifications

5.1. Pressure temperature diagram

With Inline sensor-fitting Type S030 standard

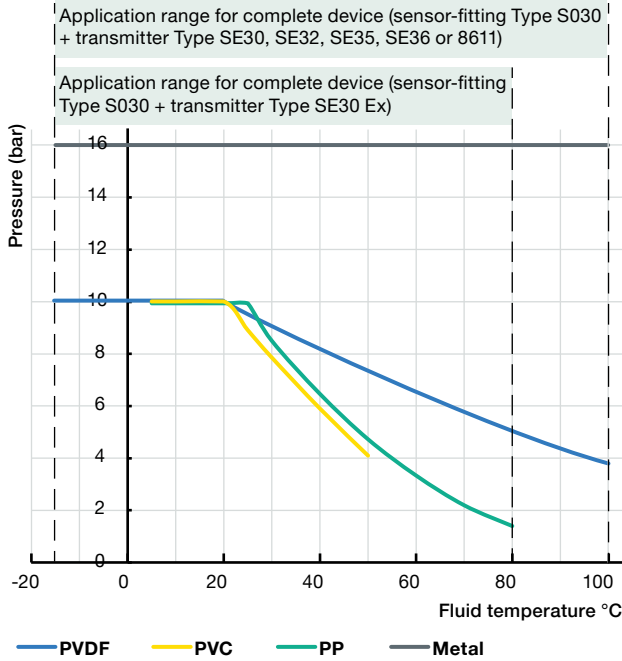

With Inline sensor-fitting Type S030 -HT

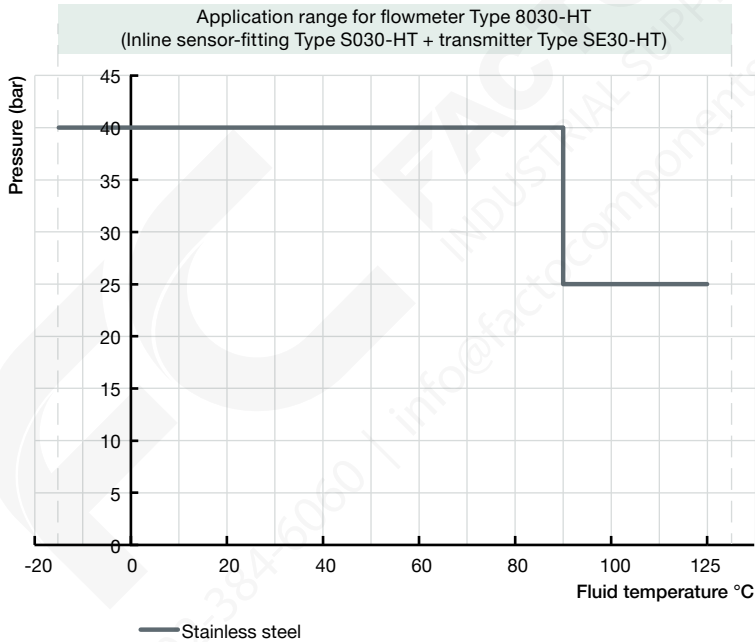

DTS 1000011766 EN Version: AK Status: RL (released | freigegeben | validé) printed: 27.05.2024

6. Product installation

6.1. Installation notes

Flow measurement

Note:

The device is not suitable for use in gaseous media and steam.

Minimum straight distances upstream and downstream of the sensor must be observed. These stabilizing distances depend on the pipe's design. Increasing these distances or installing a flow conditioner may be necessary to obtain the best accuracy. For more information, refer to EN ISO 5167-1.

EN ISO 5167-1 specifies the straight inlet and outlet distances that must be complied with when installing fittings in pipe lines in order to achieve calm flow conditions. The most commonly used elements that could lead to turbulence in the flow are shown below. The related minimum inlet and outlet distances that ensure a calm flow are also specified.

Make sure that the measuring conditions at the point of measurement are calm and problem-free.

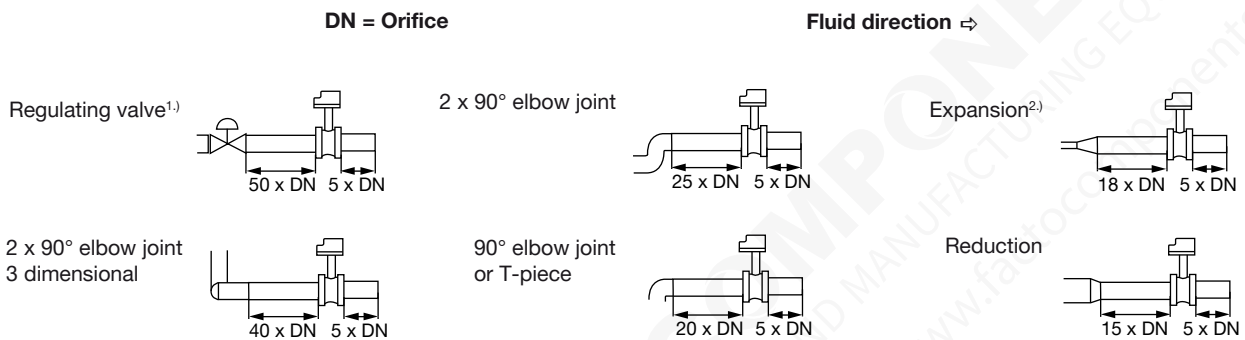

1.) If the valve cannot be mounted after the measuring device, the minimal distances have to be respected.

2.) If an expansion cannot be avoided, the minimal distances have to be respected.

Please note minimum flow velocity

The complete measuring device can be installed in either horizontal or vertical pipes, but following additional conditions should be respected:

- The pipe always has to be filled with fluid at all times near the device.
- The pipe design must be such that no air bubbles or cavitation can form within the medium near the device at any time.

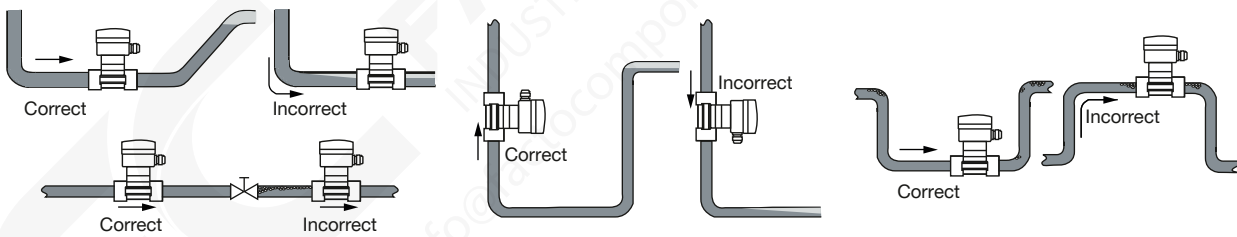

Pressure and temperature ratings must be respected according to the selected fitting material. The suitable pipe size is selected using the diagram in the chapter "Nominal size selection" of the fitting, see chapter "6.2. Selection of the nominal diameter" on page 15.

DTS 1000011766 EN Version: AK Status: RL (released | freigegeben | validé) printed: 27.05.2024

6.2. Selection of the nominal diameter

The following graph is used to determine the appropriate DN of the pipe and fitting for the application, according to the fluid velocity and the flow rate. On the chart, the intersection of flow velocity and flow rate gives the appropriate diameter.

Note:

- For the fittings listed below, the corresponding nominal size in the bracket must be used:
 - External threads acc. to SMS 1145
 - Weld ends acc. to SMS 3008, BS4825-1/ASME BPE/DIN 11866 series C or DIN 11850 series 2/DIN 11866 series A/ DIN EN 10357 series A
 - Clamp acc. to SMS 3017, BS 4825-3/ASME BPE or DIN 32676 series A.
- For all other fittings, the corresponding nominal diameter without bracket applies.

Example 1:

- Nominal flow: 10 m³/h
 - Optimal flow rate: 2...3 m/s
- Result: Select a pipe size of DN 40

Example 2 with external threads according to SMS 1145:

- Nominal flow: 10 m³/h
 - Optimal flow rate: 2...3 m/s
- Result: Select a pipe size of DN 50

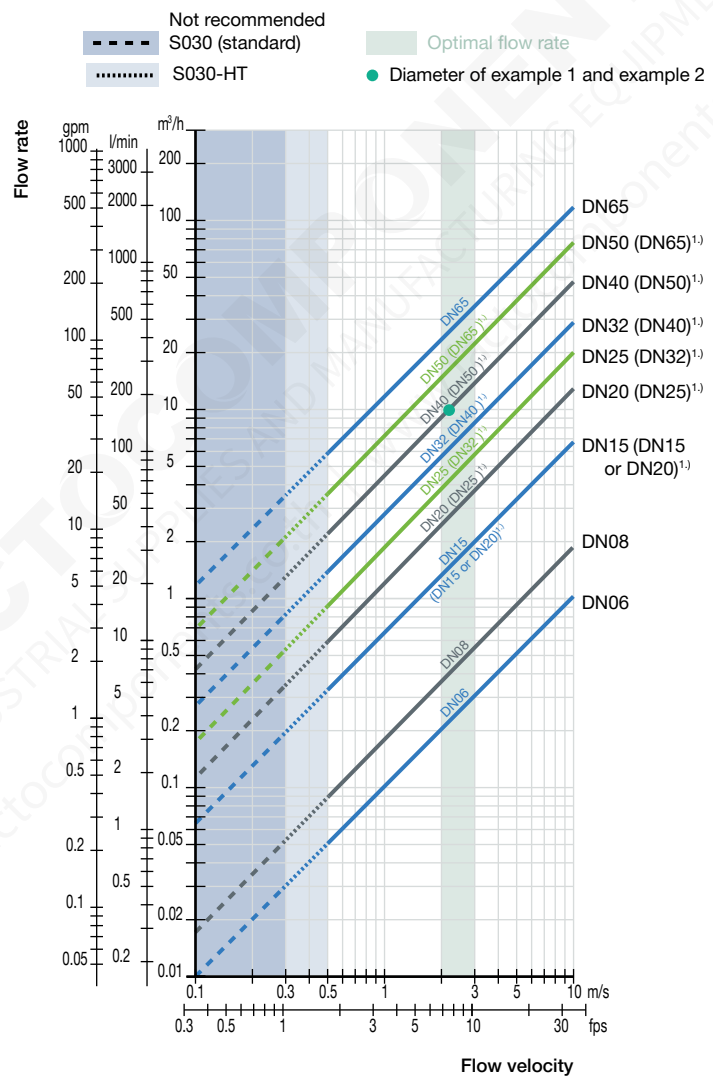

1.) See note at the beginning of this chapter.

7. Product operation

7.1. Measuring principle

When liquid flows through the pipe, the paddle wheel with 4 inserted magnets is set in rotation producing a frequency signal in the transducer (Hall sensor) of the mounted transmitter. The rotation is detected contactless through the sensor-fitting wall. The frequency modulated induced voltage is proportional to the flow velocity of the fluid.

8. Product design and assembly

8.1. Product assembly

Note:

- A complete device to measure the flow rate is made up of an sensor-fitting Type S030 equipped with a paddle wheel sensor and a Bürkert transmitter Type SE30, SE30 Ex, SE32, SE35, SE36 or 8611.
- The sensor-fitting Type S030 ensures simple installation into pipes from DN 06...DN 65. The transmitter Type SE30, SE30 Ex, SE32, SE35, SE36 or 8611 can be mounted on any sensor-fitting Type S030 and fastened with a bayonet catch.
- The drawing shows the assembly of a sensor-fitting Type S030 with a process true union connection with nut and solvent/fusion socket and a transmitter Type SE32 (Type S030 + Type SE32 = Type 8032). This also applies to all variants of process connection and compatible type of transmitter.

See **Data sheet Type 8030** ▶ Inline flowmeter, **Data sheet Type 8032** ▶ Inline flowmeter/threshold detector, **Data sheet Type 8035** ▶ Inline flowmeter or batch controller, **Data sheet Type 8036** ▶ Inline flowmeter, ELEMENT design or **Data sheet Type 8611** ▶ eCONTROL - Universal controller for more information.

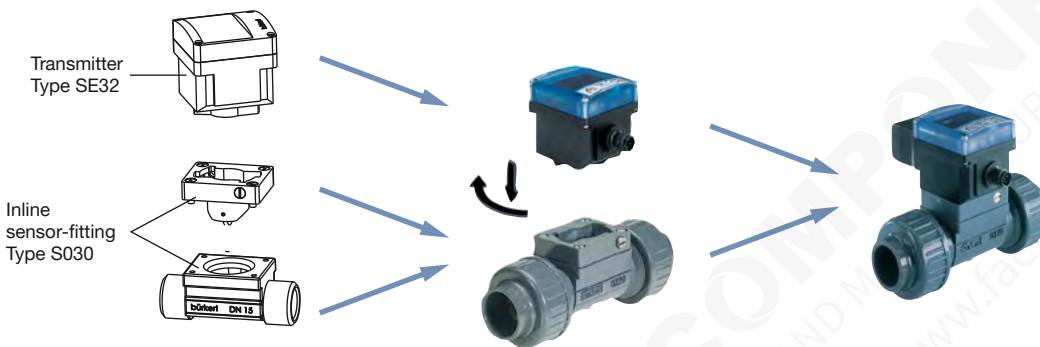

9. Product accessories

Note:

Since March 2012, the Type S030 sensor-fittings in DN 15 and DN 20 have been available in 2 variants with different K factors. Further information can be found in the user manual in the K factor chapter, see **Type S030** ▶ **Type S030-HT** ▶. The 2nd variant is identified by the “v2” marking. This “v2” marking can be found:

- on the bottom of the DN 15 or DN 20 sensor-fitting in plastic



- on the side of the DN 15 or DN 20 sensor-fitting in metal



Accessories	No.	Description
	1	Sensor holder
	2	O-ring set for metal sensor-fitting
	3	O-ring set for plastic sensor-fitting (O-Ring for process connection and seal ^{1.)} for sensor holder).

1.) Depends on sensor armature variant: flat seal to use for armature with groove (previous variant, no longer available), O-ring seal to use for armature with chamfer (variant “v2”)

DTS 1000011766 EN Version: AK Status: RL (released | freigegeben | validé) printed: 27.05.2024

10. Networking and combination with other Bürkert products

Example:



Type S030



1.) Only for SE30Ex: depending on the category, to be used with an intrinsic safety barrier with NAMUR input

DTS 1000011766 EN Version: AK Status: RL (released | freigegeben | validé) printed: 27.05.2024

11. Ordering information

11.1. Bürkert eShop



Bürkert eShop – Easy ordering and quick delivery

You want to find your desired Bürkert product or spare part quickly and order directly? Our online shop is available for you 24/7. Sign up and enjoy all the benefits.

[Order online now](#)

11.2. Recommendation regarding product selection

A complete device to measure the flow rate is made up of a compact sensor-fitting (Type S030) with paddle wheel and a transmitter (Type SE30, SE30 Ex, SE32, SE35, SE36 or 8611).

Two different components must be ordered in order to select a complete device. The following information is required:

- **Article no.** of the desired flow transmitter (see [Data sheet Type 8030](#) ▶, [Data sheet Type 8032](#) ▶, [Data sheet Type 8035](#) ▶, [Data sheet Type 8036](#) ▶ or [Data sheet Type 8611](#) ▶)
- **Article no.** of the selected S030 sensor-fitting (see chapter [“11.4. Ordering chart”](#) on page 19)

11.3. Bürkert product filter



Bürkert product filter – Get quickly to the right product

You want to select products comfortably based on your technical requirements? Use the Bürkert product filter and find suitable articles for your application quickly and easily.

[Try out our product filter](#)

11.4. Ordering chart

Metal sensor-fitting

Standard	Article no.									
	DN 06 ^{1.)} - 1/4"	DN 06 ^{1.)} - 1/2"	DN 08 ^{1.)} - 1/2"	DN 15	DN 20	DN 25	DN 32	DN 40	DN 50	DN 65
Brass - with PVDF paddle wheel - Fluid temperature max. 100 °C, PN 16										
FKM seal										
Internal thread connection										
G	-	-	-	423980 ₪	423981 ₪	423982 ₪	423983 ₪	423984 ₪	423985 ₪	-
NPT	-	-	-	423986 ₪	423987 ₪	423988 ₪	423989 ₪	423990 ₪	423991 ₪	-
Rc	-	-	-	423992 ₪	423993 ₪	423994 ₪	423995 ₪	423996 ₪	423997 ₪	-
External thread connection										
G	552557 ₪	552527 ₪	444023 ₪	423998 ₪	423999 ₪	424000 ₪	424001 ₪	-	-	-
NPT	-	-	449182 ₪	-	-	-	-	-	-	-
Rc	-	-	448668 ₪	-	-	-	-	-	-	-
Stainless steel - with PVDF paddle wheel - Fluid temperature max. 100 °C, PN 16										
FKM seal										
Internal thread connection										
G	-	-	-	424004 ₪	424005 ₪	424006 ₪	424007 ₪	424008 ₪	424009 ₪	-
NPT	-	-	-	424010 ₪	424011 ₪	424012 ₪	424013 ₪	424014 ₪	424015 ₪	-
Rc	-	-	-	424016 ₪	424017 ₪	424018 ₪	424019 ₪	424020 ₪	424021 ₪	-
External thread connection										
G	552733 ₪	552559 ₪	444029 ₪	424022 ₪	424023 ₪	424024 ₪	424025 ₪	-	-	-
NPT	-	-	449050 ₪	-	-	-	-	-	-	-
Rc	-	-	448669 ₪	-	-	-	-	-	-	-
Weld end spigot connection										
EN ISO 1127/ ISO 4200/ DIN 11866 series B	-	-	552845 ₪ 3.)	424028 ₪	424029 ₪	424030 ₪	424031 ₪	424032 ₪	424033 ₪	-
Clamp connection										
DIN 32676 series B	-	-	-	424034 ₪ 4.)	424035 ₪	424036 ₪	424037 ₪	424038 ₪	424039 ₪	-
Flange connection										
EN 1092-1/B1/PN 16	-	-	-	424040 ₪	424041 ₪	424042 ₪	424043 ₪	424044 ₪	424045 ₪	-
ANSI B16-5	-	-	-	424046 ₪	424047 ₪	424048 ₪	424049 ₪	424050 ₪	424051 ₪	-
JIS 10K	-	-	-	430108 ₪	430109 ₪	430110 ₪	430111 ₪	430112 ₪	430113 ₪	-
EPDM seal										
External thread connection										
SMS 1145	-	-	-	-	-	443306 ₪	-	443307 ₪	443308 ₪	-
Weld end spigot connection										
SMS 3008	-	-	-	-	-	443298 ₪	-	443299 ₪	443300 ₪	443374 ₪ 6.)
BS 4825-1/ ASME BPE/ DIN 11866 series C	-	-	-	-	443369 ₪ 5.)	443370 ₪	443371 ₪	443372 ₪	443373 ₪	443374 ₪
DIN 11850 series 2/ DIN 11866 series A/ DIN EN 10357 series A	-	-	551788 ₪	551789 ₪	551790 ₪	551791 ₪	-	551792 ₪	551793 ₪	-
Clamp connection										
SMS 3017	-	-	-	-	-	443302 ₪	-	443303 ₪	443304 ₪	443399 ₪ 6.)
SMS 3017 ^{2.)}	-	-	-	-	-	443387 ₪	-	443388 ₪	443389 ₪	443720 ₪ 6.)
BS 4825-3/ ASME BPE	-	-	-	-	443395 ₪ 5.)	443396 ₪	-	443397 ₪	443398 ₪	443399 ₪
BS 4825-3/ ASME BPE ^{2.)}	-	-	-	-	443400 ₪	443717 ₪	-	443718 ₪	443719 ₪	443720 ₪
DIN 32676 series A	-	-	551794 ₪ 4.)	551795 ₪ 4.)	551796 ₪	551797 ₪	-	551798 ₪	551799 ₪	-

DTS 1000011766 EN Version: AK Status: RL (released | freigegeben | validé) printed: 27.05.2024

Standard	Article no.									
	DN 06 ^{1.)} - 1/4"	DN 06 ^{1.)} - 1/2"	DN 08 ^{1.)} - 1/2"	DN 15	DN 20	DN 25	DN 32	DN 40	DN 50	DN 65
Stainless steel - with PVDF paddle wheel - Fluid temperature max. 100 °C, PN 40										
FKM seal										
Internal thread connection										
G	-	-	-	427138	425737	425729	427152	427153	427154	-

- 1.) External thread
- 2.) Internal surface finish Ra < 0.8 µm
- 3.) EPDM seal
- 4.) Refer to clamp with D dimensions of 34 mm (see chapter "Clamp connection" on page 10)
- 5.) DN 20 (3/4") only available in ASME BPE
- 6.) Refer to ASME BPE

Further variants on request

Process connection
 External thread connection: Metric in mm

Plastic sensor-fitting

Standard	Article no.									
	DN 06 ^{1.)} - 1/4"	DN 06 ^{1.)} - 1/2"	DN 08 ^{1.)} - 1/2"	DN 15	DN 20	DN 25	DN 32	DN 40	DN 50	DN 65
PVC - with PVDF paddle wheel - Fluid temperature max. 50 °C, PN 10										
FKM seal										
True union connection with nut and solvent socket										
DIN 8063	-	-	444022	423938	423939	423940	423941	423942	423943	-
ASTM D 1785/76	-	-	-	423950	423951	423952	423953	423954	423955	-
JIS K	-	-	-	429072	429073	429074	429075	429076	429077	-
External thread connection										
G	-	552560	444025	-	-	-	-	-	-	-
Solvent spigot connection										
DIN 8063	-	-	-	423944	423945	423946	423947	423948	423949	-
True union connection with nut and without socket										
-	-	-	-	430734	430735	430736	430737	430738	430739	-
EPDM seal										
True union connection with nut and without socket										
-	-	-	-	430740	430741	430742	430743	430744	430745	-
PP - with PVDF paddle wheel - Fluid temperature max. 80 °C, PN 10										
FKM seal										
True union connection with nut and fusion socket										
DIN 16962	-	-	-	423956	423957	423958	423959	423960	423961	-
Fusion spigot connection										
DIN 16962	-	-	-	423962	423963	423964	423965	423966	423967	-
PVDF - with PVDF paddle wheel - Fluid temperature max. 100 °C, PN 10										
FKM seal										
True union connection with nut and fusion socket										
ISO 10931	-	-	-	423968	423969	423970	423971	423972	423973	-
External thread connection										
ISO 10931	-	-	444028	-	-	-	-	-	-	-
Fusion spigot connection										
ISO 10931	-	-	-	423974	423975	423976	423977	423978	423979	-

1.) External thread

DTS 1000011766 EN Version: AK Status: RL (released | freigegeben | validé) printed: 27.05.2024

Stainless steel sensor-fitting (S030-HT variant)

Note:

Only mount with transmitter Type SE30 in variant High Temperature (Type SE30-HT). This combination gives the High Temperature flowmeter variant (Type 8030-HT), see **Data sheet Type 8030** ▶.

Standard	Article no.							
	DN 06 ^{1.)} -1/4"	DN 08 ^{1.)} -1/2"	DN 15	DN 20	DN 25	DN 32	DN 40	DN 50
With stainless steel paddle wheel - Fluid temperature max. 125 °C, PN 25 (max. 90 °C, PN 40)								
FKM seal								
Internal thread connection								
G	-	-	449726	449727	449728	449729	449730	449731
NPT	-	-	449733	449734	449735	449736	449737	449738
Rc	-	-	449740	449741	449742	449743	449744	449745
External thread connection								
G	552735	449725	-	-	-	-	-	-
NPT	-	449732	-	-	-	-	-	-
Rc	-	449739	-	-	-	-	-	-
Weld end connection								
EN ISO 1127/ISO 4200/ DIN 11866 series B	-	-	551757	551758	551759	551760	551761	551762

1.) External thread

Further variants on request	
Material EPDM seal	Process connection Clamp or flange

11.5. Ordering chart accessories

Note:

Since March 2012, the Type S030 sensor-fittings in DN 15 and DN 20 exist in 2 variants, with different K factors. The 2nd variant is identified by the “v2” marking.

See chapter “9. Product accessories” on page 16.

Description	Article no.
Sensor armature set	
Sensor armature made of stainless steel with paddle wheel (PVDF), seal (FKM), screws and test certificate for DN 06, DN 08, DN 15 v2 and DN 20 v2	448678
Sensor armature made of stainless steel with paddle wheel (PVDF), seal (FKM), screws and test certificate for DN 15 (except DN 15 v2 and DN 20 v2)...DN 65	432306
Sensor armature made of stainless steel with paddle wheel (PVDF), seal (EPDM), screws and test certificate for DN 15 (except DN 15 v2 and DN 20 v2)...DN 65	432305
Sensor armature made of stainless steel with paddle wheel (PVDF), seal (EPDM), screws and test certificate, Ra int. <0.8 µm for DN 15 (except DN 15 v2 and DN 20 v2)...DN 65	434149
Sensor armature made of stainless steel with paddle wheel (PP), seal (EPDM), screws and test certificate for DN 06, DN 08, DN 15 v2 and DN 20 v2	554896
Sensor armature made of stainless steel with paddle wheel (PP), seal (EPDM), screws and test certificate for DN 15 (except DN 15 v2 and DN 20 v2)...DN 65	449425
Sensor armature made of brass with paddle wheel (PVDF), seal (FKM), screws and test certificate for DN 06, DN 08, DN 15 v2 and DN 20 v2	448677
Sensor armature made of brass with paddle wheel (PVDF), seal (FKM), screws and test certificate for DN 15 (except DN 15 v2 and DN 20 v2)...DN 65	432304
Sensor armature made of brass with paddle wheel (PVDF), seal (EPDM), screws and test certificate for DN 15 (except DN 15 v2 and DN 20 v2)...DN 65	432303
Sensor armature made of brass with paddle wheel (PP), seal (EPDM), screws and test certificate for DN 15 (except DN 15 v2 and DN 20 v2)...DN 65	449866
Sensor armature made of PVC with paddle wheel (PVDF), seal (FKM), screws and test certificate for DN 06, DN 08, DN 15 v2 and DN 20 v2	448674
Sensor armature made of PVC with paddle wheel (PVDF), seal (FKM), screws and test certificate for DN 15 (except DN 15 v2 and DN 20 v2)...DN 65	432298

Sensor armature made of PVC with paddle wheel (PVDF), seal (EPDM), screws and test certificate for DN 15 (except DN 15 v2 and DN 20 v2)...DN 65	432297
Sensor armature made of PVC with paddle wheel (PP), seal (EPDM), screws and test certificate for DN 15 (except DN 15 v2 and DN 20 v2)...DN 65	443982
Sensor armature made of PP with paddle wheel (PVDF), seal (FKM), screws and test certificate for DN 15...DN 65	432300
Sensor armature made of PP with paddle wheel (PVDF), seal (EPDM), screws and test certificate for DN 15...DN 65	432299
Sensor armature made of PP with paddle wheel (PP), seal (FKM), screws and test certificate for DN 15...DN 65	552881
Sensor armature made of PP with paddle wheel (PP), seal (EPDM), screws and test certificate for DN 15...DN 65	443983
Sensor armature made of PVDF with paddle wheel (PVDF), seal (FKM), screws and test certificate for DN 06, DN 08, DN 15 v2 and DN 20 v2	448676
Sensor armature made of PVDF with paddle wheel (PVDF), seal (FKM), screws and test certificate for DN 15 (except DN 15 v2 and DN 20 v2)...DN 65	432302
Sensor armature made of PVDF with paddle wheel (PVDF), seal (EPDM), screws and test certificate for DN 15 (except DN 15 v2 and DN 20 v2)...DN 65	432301
Sensor armature set for High Temperature variant	
Sensor armature made of stainless steel with paddle wheel (stainless steel), seal (FKM) and screws for DN 15 (except DN 15 v2 and DN 20 v2)...DN 50	551764
Sensor armature made of stainless steel with paddle wheel (stainless steel), seal (FKM) and screws for DN 06, DN 08, DN 15 v2 and DN 20 v2	449723
Sensor armature made of stainless steel with paddle wheel (stainless steel), seal (EPDM) and screws for DN 15 (except DN 15 v2 and DN 20 v2)...DN 50	551763
Sensor armature in stainless steel with paddle wheel (stainless steel), seal (EPDM) and screws for DN 06, DN 08, DN 15 v2 and DN 20 v2	449724
O-ring set	
FKM O-ring for metal fitting, DN 06...DN 65	426340
EPDM O-ring for metal fitting, DN 06...DN 65	426341
FKM O-ring for plastic fitting, DN 08	448679
FKM O-ring for plastic fitting, DN 15	431555
FKM O-ring for plastic fitting, DN 20	431556
FKM O-ring for plastic fitting, DN 25	431557
FKM O-ring for plastic fitting, DN 32	431558
FKM O-ring for plastic fitting, DN 40	431559
FKM O-ring for plastic fitting, DN 50	431560
EPDM O-ring for plastic fitting, DN 08	448680
EPDM O-ring for plastic fitting, DN 15	431561
EPDM O-ring for plastic fitting, DN 20	431562
EPDM O-ring for plastic fitting, DN 25	431563
EPDM O-ring for plastic fitting, DN 32	431564
EPDM O-ring for plastic fitting, DN 40	431565
EPDM O-ring for plastic fitting, DN 50	431566
Approvals and conformities	
3-point flow calibration certificate ^{1.)}	550676
Inspection certificate 3.1 (according to EN-ISO 10204)	803723
Test report 2.2 (according to EN-ISO 10204)	803722
Certification of conformity for the surface finish (according to DIN4762, DIN4768, ISO/4287/1)	804175
FDA declaration of conformity	803724

1.) S030 combined with the plugged-in flow transmitter, only for DN ≤200

DTS 1000011766 EN Version: AK Status: RL (released | freigegeben | validé) printed: 27.05.2024