



Conductivity sensor

- Compact variant for DN 15...DN 200
- Wide range of conductivity measurement thanks to different cells
- Broad range of process connections with various fittings

Product variants described in the data sheet may differ from the product presentation and description.

Can be combined with

- | | |
|--|---|
| | <p>Type 8619 ▶
multiCELL - Multi-channel and multi-function transmitter/controller</p> |
| | <p>Type S020 ▶
Insertion fitting for flow or analytical measurement</p> |

Type description

The conductivity sensor consists of a compact probe with integrated electrodes. Four conductivity probes with different cell constants are available and offer a broad measurement range. The Pt1000 for automatic temperature compensation is integrated in the sensor housing.

The sensor delivers a raw signal and is fitted with a standard EN 175301-803 plug connector. The sensor has to be connected to the Bürkert transmitter/controller Type 8619 multiCELL via a 4 x 1.5 mm² shielded cable (maximum cable length of 10 m).

The conductivity sensor can be installed into a pipe by using Insertion fitting Type S020 which is available in different materials (details see data sheet Type S020). In its longer variant it can also be installed in tanks or containers by using an industrial immersion fitting.



Table of contents

1. General technical data	3
2. Approvals and conformities	5
2.1. Conformity	5
2.2. Standards.....	5
2.3. Pressure Equipment Directive (PED).....	5
Device used on a pipe	5
Device used on a vessel	5
3. Materials	5
3.1. Bürkert resistApp	5
3.2. Material specifications	6
4. Dimensions	6
4.1. Compact variant.....	6
4.2. Compact variant installed in an Insertion fitting Type S020.....	7
4.3. Immersion fitting for extended variant of sensor	7
5. Performance specifications	8
5.1. Pressure temperature diagram.....	8
6. Product installation	8
6.1. Installation notes	8
Device used on a pipe	8
Device used on a vessel	8
6.2. Mounting options	9
Device used on a pipe	9
7. Product operation	9
7.1. Measuring principle.....	9
8. Product design and assembly	10
8.1. Product assembly	10
Device used on a pipe	10
Device used on a vessel	11
9. Product accessories	12
9.1. Accessory	12
10. Networking and combination with other Bürkert products	13
10.1. Combination with transmitter/controller and fitting	13
10.2. Combination with available Type S020 Insertion fittings DN	13
11. Ordering information	13
11.1. Bürkert eShop.....	13
11.2. Recommendation regarding product selection.....	14
Device used on a pipe	14
Device used on a vessel	14
11.3. Bürkert product filter	14
11.4. Ordering chart.....	14
11.5. Ordering chart accessories.....	15

1. General technical data

Product properties

Material

Make sure the device materials are compatible with the fluid you are using.
Further information can be found in chapter "3.1. Bürkert resistApp" on page 5.

Further information on the materials can be found in chapter "3.2. Material specifications" on page 6.

Non wetted parts

Housing	PC
Screw	Stainless steel
Union nut	PC
Pt1000	Stainless steel 1.4571 (316Ti) for variants with cell constant C=0.01 or C=0.1 cm ⁻¹
Female cable plug/male fixed plug	<ul style="list-style-type: none"> Body, contact holder and cable gland in PA Cable gland seal and flat seal in NBR

Wetted parts

Sensor holder	PVDF
Electrode	<ul style="list-style-type: none"> Stainless steel 1.4571 (316Ti) for variants with cell constant C=0.01 or 0.1 cm⁻¹ Graphite for variants with cell constant C=1.0 or 10 cm⁻¹
Pt1000	Stainless steel 1.4571 (316Ti) for variants with cell constant C=1 or 10 cm ⁻¹
Seal	FKM (EPDM included in delivery)
Compatibility	With fittings Type S020 See data sheet Type S020 ► for more information.
Pipe diameter	DN 15...DN 200
Dimensions	Further information can be found in chapter "4. Dimensions" on page 6.
Temperature sensor	Pt1000 integrated within the holder
Temperature compensation	Through the connected multiCELL transmitter/controller Type 8619 See data sheet Type 8619 ► for more information.

Measuring range

Conductivity measurement	0.05 µS/cm...200 mS/cm (depending on cell constant)
Temperature measurement	-50...+150 °C (-58...+302 °F)

Performance data

Conductivity measurement

Measurement deviation	<ul style="list-style-type: none"> Typical: 3 % of measured value Max.: 5 % of measured value
-----------------------	---

Temperature measurement

Measurement deviation	±1 °C
Measuring range resolution	0.1 °C

Electrical data

Operating voltage	None
Output	Raw signal, to be connected to the multiCELL transmitter/controller Type 8619. See data sheet Type 8619 ► for more information.
Voltage supply cable	<ul style="list-style-type: none"> 4 × 0.25...1.5 mm² shielded Max. 10 m between Type 8220 and Type 8619

Medium data

Fluid temperature	With fitting Type S020 in: <ul style="list-style-type: none"> PVC: 0...+50 °C (+32...+122 °F) PP: 0...+80 °C (+32...+176 °F) PVDF, stainless steel, brass: 0...+100 °C (+32...+212 °F) See data sheet Type S020 ► for more information.
Fluid pressure	Max. PN 10 Further information can be found in chapter "5.1. Pressure temperature diagram" on page 8.

Process/Pipe connection & communication

Process connection	G 2" for use with Type S020 Insertion fitting See data sheet Type S020 ► for more information.
Electrical connection	Female cable plug according to EN 175301-803

Approvals and conformities

Directives

CE directive	Further information on the CE Directive can be found in chapter “ 2.2. Standards ” on page 5.
Pressure equipment directive	Complying with article 4, paragraph 1 of 2014/68/EU directive Further information on the pressure equipment directive can be found in chapter “ 2.3. Pressure Equipment Directive (PED) ” on page 5.

Environment and installation

Ambient temperature	Operation and storage: 0...+60 °C (+32...+140 °F)
Relative air humidity	≤ 80 %, without condensation
Height above sea level	Max. 2000 m
Operating condition	Continuous
Equipment mobility	Fixed
Application range	Indoor and outdoor Protect the device against electromagnetic interference, ultraviolet rays and, when installed outdoors, against the effects of climatic conditions.
Degree of protection according to IEC/EN 60529	IP65 with cable plug mounted and tightened
Installation category	Category I according to UL/EN 61010-1
Pollution degree	Degree 2 according to UL/EN 61010-1

2. Approvals and conformities

2.1. Conformity

In accordance with the Declaration of Conformity, the product is compliant with the EU Directives.

2.2. Standards

The applied standards which are used to demonstrate compliance with the EU Directives are listed in the EU-Type Examination Certificate and/or the EU Declaration of Conformity.

2.3. Pressure Equipment Directive (PED)

The device conforms to article 4, paragraph 1 of the Pressure Equipment Directive (PED) 2014/68/EU under the following conditions:

Device used on a pipe

Note:

- The data in the table is independent of the chemical compatibility of the material and the fluid.
- PS = maximum admissible pressure (in bar), DN = nominal diameter of the pipe

Type of fluid	Conditions
Fluid group 1, article 4, paragraph 1.c.i	DN ≤ 25
Fluid group 2, article 4, paragraph 1.c.i	DN ≤ 32 or PS*DN ≤ 1000
Fluid group 1, article 4, paragraph 1.c.ii	DN ≤ 25 or PS*DN ≤ 2000
Fluid group 2, article 4, paragraph 1.c.ii	DN ≤ 200 or PS ≤ 10 or PS*DN ≤ 5000

Device used on a vessel

Note:

- The data in the table is independent of the chemical compatibility of the material and the fluid.
- PS = maximum admissible pressure (in bar), V = vessel volume

Type of fluid	Conditions
Fluid group 1, article 4, paragraph 1.a.i	V > 1 L and PS*V ≤ 25 bar.L or PS ≤ 200 bar
Fluid group 2, article 4, paragraph 1.a.i	V > 1 L and PS*V ≤ 50 bar.L or PS ≤ 1000 bar
Fluid group 1, article 4, paragraph 1.a.ii	V > 1 L and PS*V ≤ 200 bar.L or PS ≤ 500 bar
Fluid group 2, article 4, paragraph 1.a.ii	PS > 10 bar and PS*V ≤ 10000 bar.L or PS ≤ 1000 bar

3. Materials

3.1. Bürkert resistApp

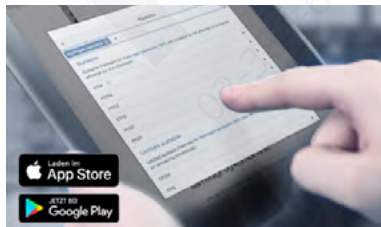

Bürkert resistApp – Chemical resistance chart

You want to ensure the reliability and durability of the materials in your individual application case? Verify your combination of media and materials on our website or in our resistApp.

[Start chemical resistance check](#)

DTS 1000141283 EN Version: P Status: RL (released | freigegeben | validé) printed: 22.04.2024

3.2. Material specifications

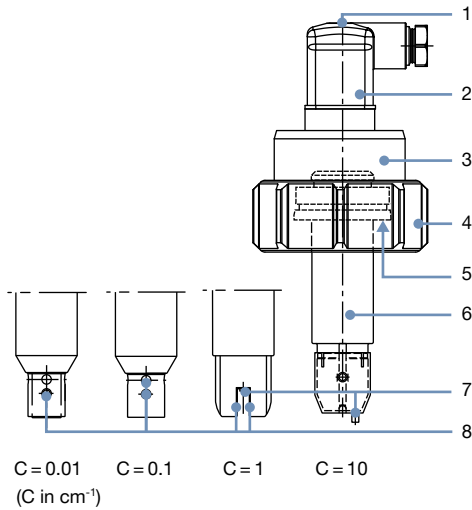

No.	Element	Material
1	Screw	Stainless steel
2	Female cable plug/male fixed plug	<ul style="list-style-type: none"> Body, contact holder and cable gland in PA Cable gland seal and flat seal in NBR
3	Housing	PC
4	Union nut	PC
5	Seal	FKM (EPDM included in delivery)
6	Sensor holder	PVDF
7	Electrode	<ul style="list-style-type: none"> Stainless steel 1.4571 (316Ti) for cell constant C=0.01 or 0.1 cm⁻¹ Graphite for cell constant C=1.0 or 10 cm⁻¹
8	Pt1000	Stainless steel 1.4571 (316Ti) for variants with cell constant C=1 or 10 cm ⁻¹ (for other variants it is integrated within the sensor holder)

4. Dimensions

4.1. Compact variant

Note:

Dimensions in mm, unless otherwise stated

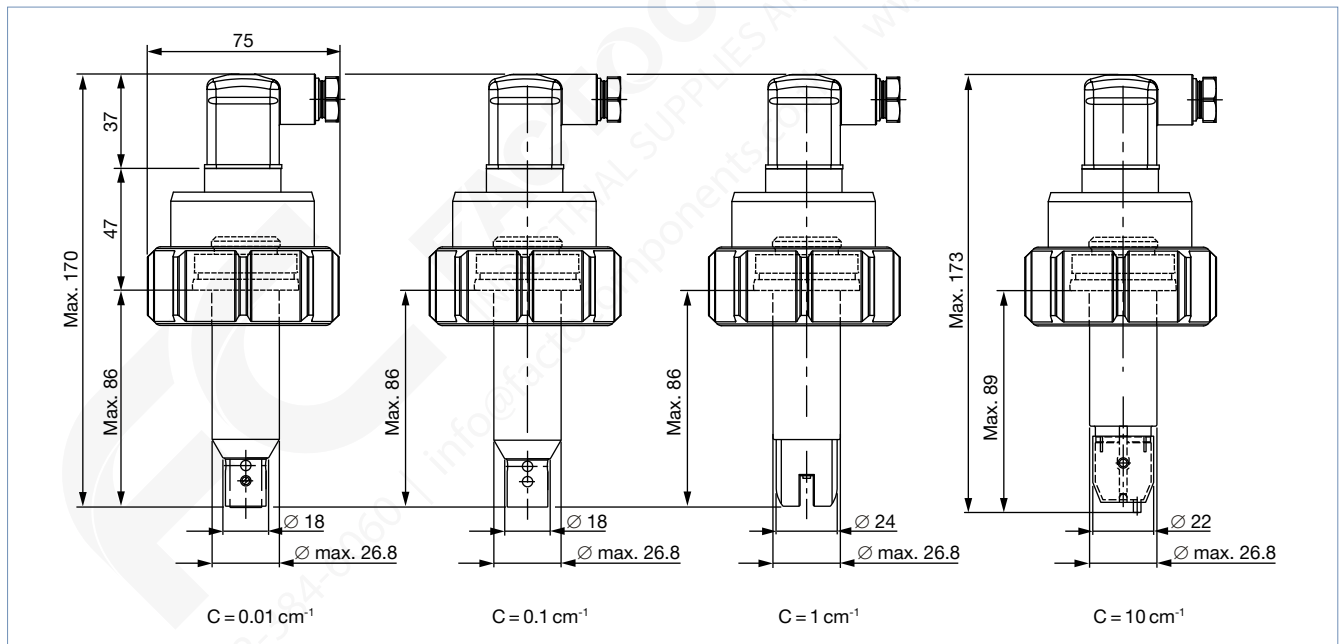

DTS 1000141283 EN Version: P Status: RL (released | freigegeben | validé) printed: 22.04.2024

4.2. Compact variant installed in an Insertion fitting Type S020

Note:

Dimensions in mm, unless otherwise stated

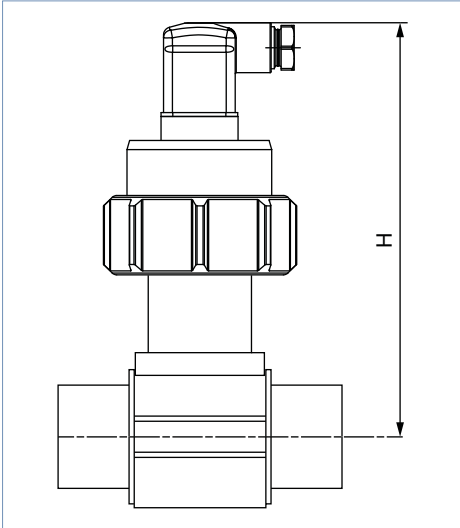

DN	H		
	T-Fitting	Plastic spigot ^{1.)}	Metal spigot
15	263.0	-	-
20	160.5	-	-
25	160.5	-	-
32	164.0	-	-
40	168.0	-	-
50	174.0	-	172.2
65	174.0	173.5	174.0
80	-	181.0	180.0
100	-	191.0	190.5
125	-	-	201.5
150	-	-	212.5
200	-	-	233.0

1.) Use fusion spigot connection (Article no. 418652, 418660 or 418644 in PP, PVDF or PE respectively) for orifice DN 65...DN 100.

4.3. Immersion fitting for extended variant of sensor

Note:

Dimensions in mm, unless otherwise stated

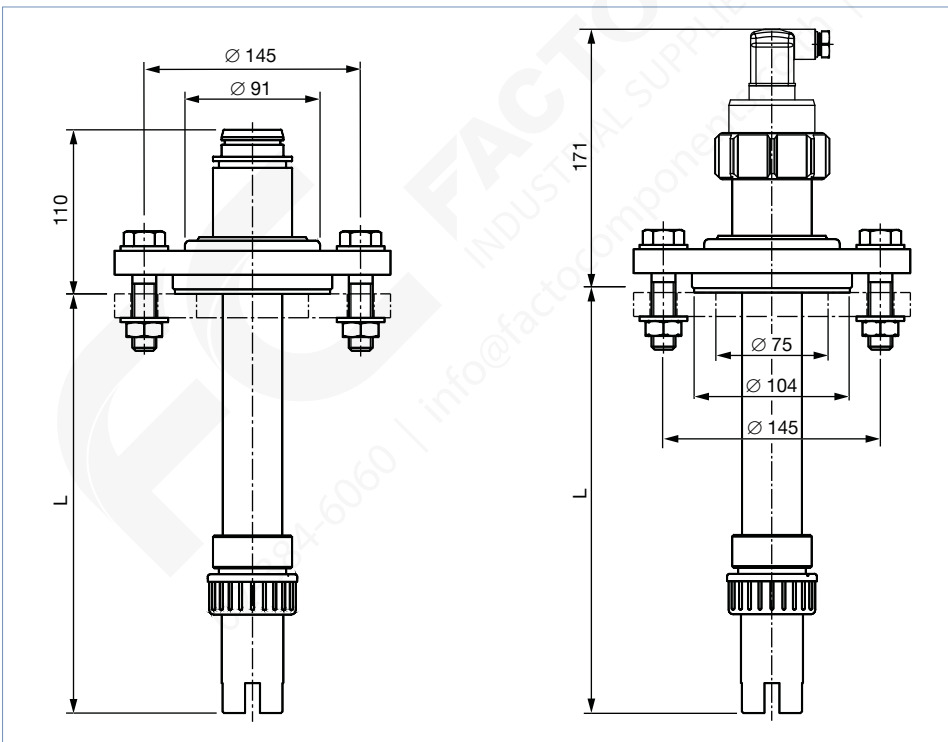

L
500
1000
1500
2000

5. Performance specifications

5.1. Pressure temperature diagram

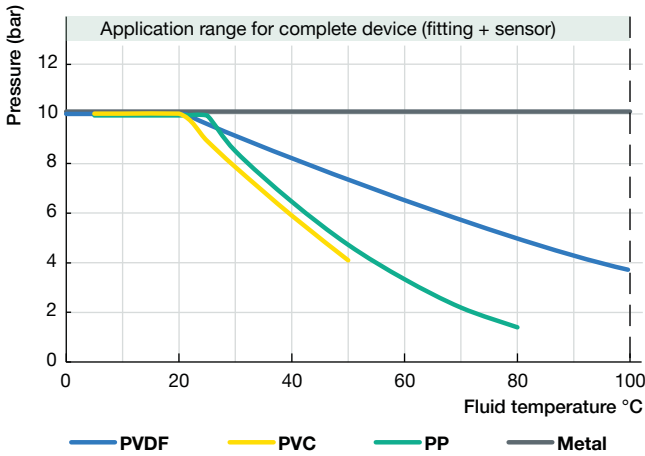

6. Product installation

6.1. Installation notes

Device used on a pipe

Note:

The device Type 8220 is installed into a Bürkert Type S020 Insertion fitting and fastened with a union nut, see **data sheet Type S020** for more information.

Installation example	Installation example
	<p>The compact conductivity sensor Type 8220 can be installed into any Bürkert Insertion fitting (Type S020). Select and install the required fitting onto the pipe, according to specific requirements of the sensor and fitting material (temperature and pressure). Then cautiously install the unit on the fitting and tighten with the nut.</p> <p>Further information on the assembly can be found in chapter “8.1. Product assembly” on page 10.</p> <p>With a cell constant C = 10 cm⁻¹, the opening hole of the small channel must be located on the flow inlet side.</p>

Device used on a vessel

Installation example	Installation example
	<p>An industrial immersion fitting allows installation of the longer variant of the sensor having a cell constant C=0.01, 0.1 or 1 cm⁻¹ into tanks or containers.</p> <p>The following lengths are available: 500, 1000, 1500, 2000 mm. Special lengths on request.</p> <p>Further information on the assembly can be found in chapter “8.1. Product assembly” on page 10.</p> <p>Further information on the required accessories can be found in chapter “9. Product accessories” on page 12.</p>

6.2. Mounting options

Device used on a pipe

Note:

- In order to get a reliable measurement, air bubbles must be avoided and the mounting location must ensure that the electrode is continuously and completely immersed in the flow stream.
- The device must be protected from heat, direct sunlight and other environmental influences.
- The sensor can be installed in any position.

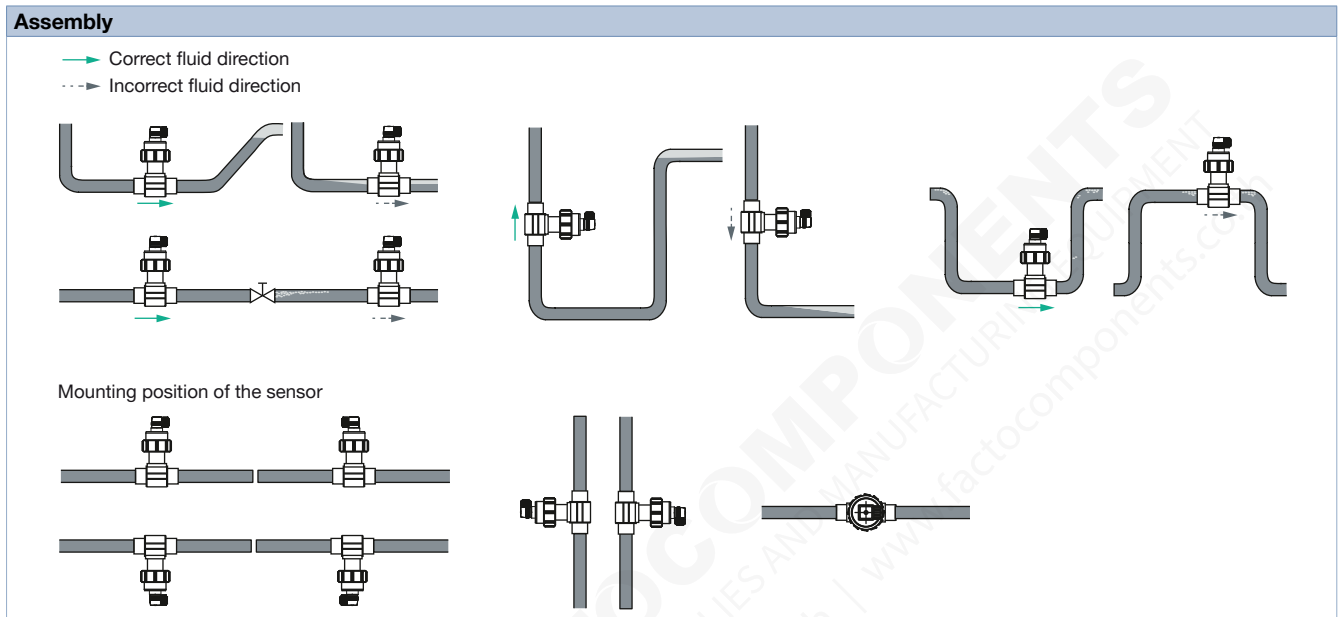

7. Product operation

7.1. Measuring principle

Conductivity is defined by the property of a solution to conduct electrical current. The charge carriers are ions (e.g. dissolved salts or acids).

In the simplest case the measurement cell consists of two metal electrodes which are set at a fixed distance apart and with a known specified surface. An AC voltage supplied from the connected transmitter/controller Type 8619 is applied to the electrodes. The measured current is a direct function of the quantity of ions contained in the solution, and with help of Ohm's law the conductivity is calculated. A 4...20 mA standard signal proportional to the conductivity is available as output signal at the connected transmitter.

There are many types of conductivity probes available, the measuring range of which varies greatly depending on the electrode assembly. To compensate for the geometry of the conductivity cell a cell constant is used: $\text{Conductivity [S/cm]} = \text{Measurement [S]} \times \text{Cell constant [1/cm]}$.

The conductivity sensor can be equipped with 4 cells with different constants $C=0.01$; 0.1 ; 1 and 10 cm^{-1} .

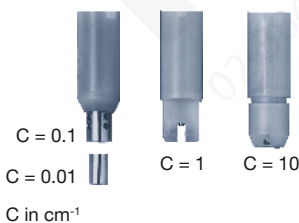

DTS 1000141283 EN Version: P Status: RL (released | freigegeben | validé) printed: 22.04.2024

The sensor is selected according to the measuring range and medium by using the table below..

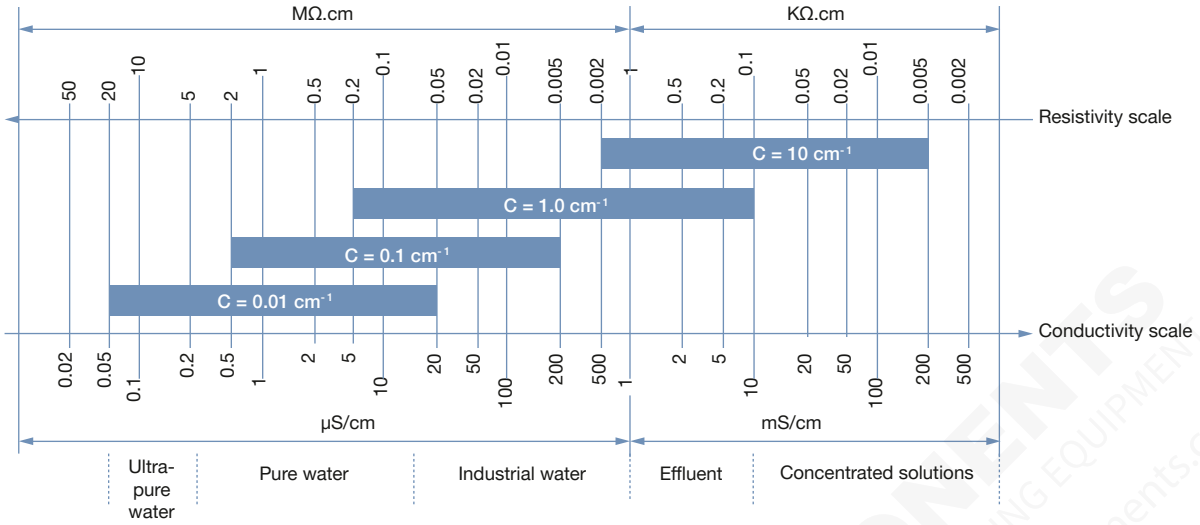

8. Product design and assembly

8.1. Product assembly

Device used on a pipe

Note:

The device Type 8220 is installed into a Bürkert Type S020 Insertion fitting and fastened with a union nut, see **data sheet Type S020** for more information.

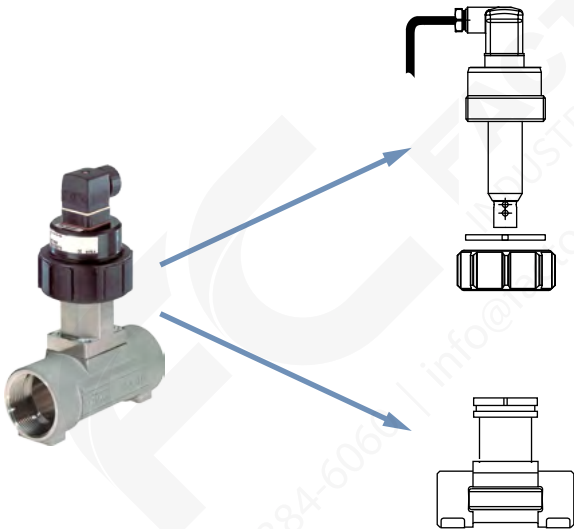

Device used on a vessel

Note:

See chapter "9. Product accessories" on page 12 for more information on the accessories used.

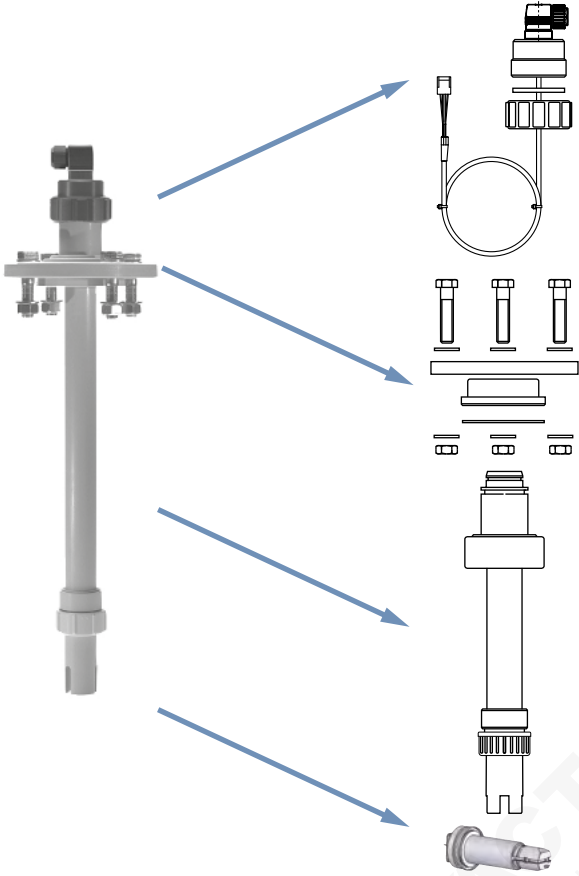

DTS 1000141283 EN Version: P Status: RL (released | freigegeben | validé) printed: 22.04.2024

FAC FACTOCOMPONENTS
INDUSTRIAL SUPPLIES AND MANUFACTURING EQUIPMENT
02-384-6060 | info@factocomponents.co.th | www.factocomponents.co.th

9. Product accessories

9.1. Accessory

Note:

- To enable the use of conductivity sensors on a tank, use the following accessories.
- See chapter „8.1. Product assembly“ on page 12 for further information on the product assembly of the conductivity sensor.

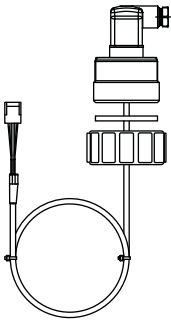
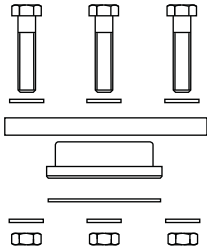
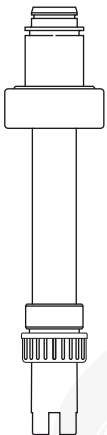
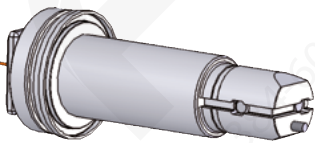
Accessory	Description
	Extension cable set with defined cable length (for pipe extension, to use with 8619 multiCELL transmitter/controller)
	Fastening set (flange DN 65 with stainless steel screws)
	Pipe extension made of PP, with different lengths
	Conductivity probe with various cell constants (with stainless steel or graphite electrode) for mounting with immersion fitting

DTS 1000141283 EN Version: P Status: RL (released | freigegeben | validé) printed: 22.04.2024

10. Networking and combination with other Bürkert products

10.1. Combination with transmitter/controller and fitting

Example:

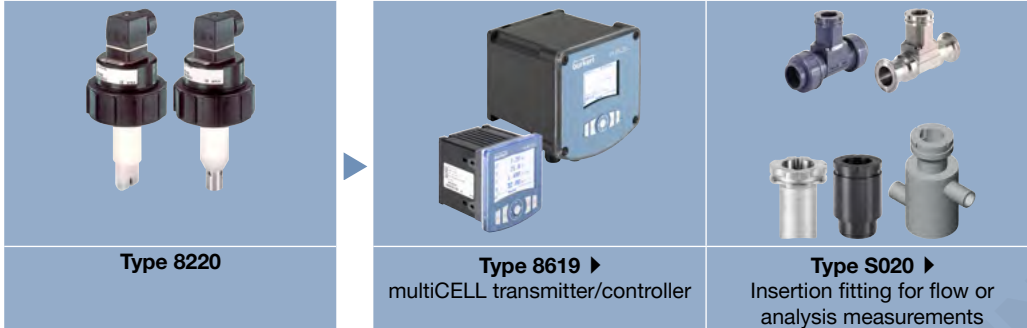

10.2. Combination with available Type S020 Insertion fittings DN

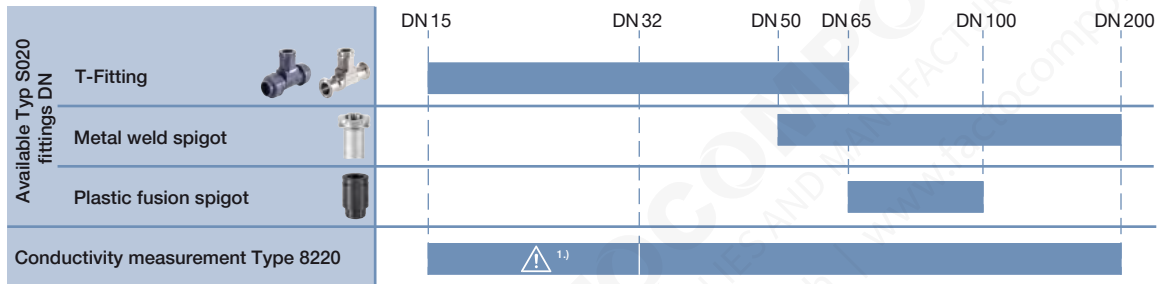

1.) Only use plastic fittings with true union process connection in analytical variant, with nut and solvent/fusion socket according to DIN 8063 (PVC), to DIN 16962 (PP) or to ISO 10931 (PVDF).

See **data sheet Type S020** ▶ for more information.

11. Ordering information

11.1. Bürkert eShop



Bürkert eShop – Easy ordering and quick delivery

You want to find your desired Bürkert product or spare part quickly and order directly? Our online shop is available for you 24/7. Sign up and enjoy all the benefits.

[Order online now](#)

11.2. Recommendation regarding product selection

Device used on a pipe

A complete conductivity measurement equipment consists
 A complete conductivity measurement equipment consists of a conductivity sensor Type 8220, a multiCELL transmitter/controller Type 8619 and a Bürkert Insertion fitting Type S020.

See [data sheet Type S020](#) ▶ and [data sheet Type 8619](#) ▶ for more information.

Three different components must be ordered in order to select a complete device. The following information is required:

- **Article no.** of the desired conductivity sensor Type 8220 (see chapter “11.4. Ordering chart” on page 14)
- **Article no.** of the desired multiCELL transmitter/controller Type 8619
- **Article no.** of the selected Insertion fitting (DN 15...DN 200) or measuring chamber Type S020

Device used on a vessel

A conductivity sensor Type 8220 for tank installation is made up of a conductivity probe, an immersion fitting which is consisting of a pipe extension, an extension cable set for pipe extension and a fastening set (flange DN 65 with stainless steel screws) and has to be connected to a multiCELL transmitter/controller Type 8619 (see chapter “9. Product accessories” on page 12).

See [data sheet Type S020](#) ▶ and [data sheet Type 8619](#) ▶ for more information.

Five different components must be ordered in order to select a complete device. The following information is required:

- **Article no.** of the desired conductivity probe – only probes with cell constant C=0.01, 0.1 and 1 are available (see chapter “11.5. Ordering chart accessories” on page 15)
- **Article no.** of the pipe extension (see chapter “11.5. Ordering chart accessories” on page 15)
- **Article no.** of the extension cable set for the pipe extension (see chapter “11.5. Ordering chart accessories” on page 15)
- **Article no.** of the fastening set (flange DN 65 with stainless steel screws, see chapter “11.5. Ordering chart accessories” on page 15)
- **Article no.** of the desired multiCELL transmitter/controller Type 8619

11.3. Bürkert product filter



Bürkert product filter – Get quickly to the right product

You want to select products comfortably based on your technical requirements?
 Use the Bürkert product filter and find suitable articles for your application quickly and easily.

















[Try out our product filter](#)

11.4. Ordering chart

Cell constant [cm ⁻¹]	Measuring range	Electrode material	Electrical connection	Article no.
0.01	0.05 µS/cm...20 µS/cm	Stainless steel	Cable plug (according to EN 175301-803)	426872
0.1	0.5 µS/cm...200 µS/cm			426873
1	5 µS/cm...10 mS/cm	Graphite		426874
10	0.5 mS/cm...200 mS/cm			426875

DTS 1000141283 EN Version: P Status: RL (released | freigegeben | validé) printed: 22.04.2024

11.5. Ordering chart accessories

Description	Article no.
Set with two cable glands M20 × 1.5, two neoprene flat seals for cable gland or plug, two screw plugs M20 × 1.5 and two multi-way seals 2 × 6 mm	449755 
Set with a green FKM seal and a black EPDM seal	552111 
Fastening ring (open) for Type S020 Insertion fitting	619205 
PC union nut for Type S020 Insertion fitting	619204 
Female cable plug, 4-pin (3 conductors + protective conductor), form A according to DIN EN 175301-803 with cable gland (Type 2518 ▶)	572264 
Female cable plug 32 mm, 4-pin (3 conductors + protective conductor), form A according to DIN EN 175301-803, with NPT ½" reduction without cable gland (Type 2509 ▶)	162673 
Pipe extension made of PP, length: 0.5 m	419567 
Pipe extension made of PP, length: 1.0 m	419568 
Pipe extension made of PP, length: 1.5 m	419569 
Pipe extension made of PP, length: 2.0 m	419570 
Fastening set (flange DN 65 with stainless steel screws)	413615 
Conductivity probe C = 0.01 (with stainless steel electrode) for mounting with immersion fitting	633367 
Conductivity probe C = 0.1 (with stainless steel electrode) for mounting with immersion fitting	631647 
Conductivity probe C = 1 (with graphite electrode) for mounting with immersion fitting	418217 
Factory certificate of 2-point conductivity calibration	550675 
Extension cable set including a 0.7 m cable (for pipe extension with a length ≤ 0.5 m for use with Type 8619 multiCELL transmitter/controller)	437615 
Extension cable set including a 1.7 m cable (for pipe extension with a length ≤ 1.5 m for use with Type 8619 multiCELL transmitter/controller)	437617 
Extension cable set including a 2.2 m cable (for pipe extension with a length ≤ 2.0 m for use with Type 8619 multiCELL transmitter/controller)	437618 