







Insertion magnetic inductive flowmeter

- Sensor without moving parts
- Flowmeter with On/Off control
- Application related calibration by Teach-In function
- Clean in place (CIP)
- FDA-compliant materials

Product variants described in the data sheet may differ from the product presentation and description.

Can be combined with

- 
Type 8025 ▶
 Insertion flowmeter/batch controller with paddle wheel and flow transmitter/remote batch controller
- 
Type 8802 ▶
 ELEMENT continuous control valve systems - overview
- 
Type 8619 ▶
 multiCELL - Multi-channel and multi-function transmitter/controller
- 
Type 8644 ▶
 AirLINE SP electropneumatic automation system

Type description

The electromagnetic flowmeter Type 8041 is made up of an electronic module and a sensor consisting of PVDF or stainless steel material. It has been designed to measure a flow rate of neutral and slightly aggressive fluids with a conductivity of more than 20 µS/cm in DN 06...DN 400 pipes.

The Type 8041 is fitted with a 4...20 mA output, a pulse output and a relay output. The different parameters can be set by means of 5 DIP switches, a push-button and a 10-field LED bar graph.

This flowmeter is available either with a G 2" connection with a PVDF sensor or, a G 2" or clamp connection with a stainless steel sensor which are designed for use with an Insertion fitting Type S020.

The variant with a stainless steel sensor can be used in applications with higher pressures (PN 16) and higher temperatures (150 °C).

DTS 1000021534 EN Version: W Status: RL (released | freigegeben | validé) printed: 19.12.2023



Table of contents

1. General technical data	4
2. Approvals and conformities	7
2.1. General notes.....	7
2.2. Conformity	7
2.3. Standards.....	7
2.4. Pressure Equipment Directive (PED).....	7
Device used on a pipe	7
2.5. North America (USA/Canada)	7
2.6. Foods and beverages/Hygiene	7
3. Materials	8
3.1. Bürkert resistApp	8
3.2. Material specifications	8
4. Dimensions	9
4.1. Flowmeter	9
With G 2" process connection	9
With clamp process connection	9
4.2. Flowmeter installed in an Insertion fitting Type S020	10
With G 2" process connection	10
With clamp process connection	10
5. Performance specifications	11
5.1. Pressure temperature diagram.....	11
Flowmeter with a PVDF sensor.....	11
Flowmeter with a stainless steel sensor	11
6. Product installation	12
6.1. Installation notes	12
6.2. Mounting options.....	12
7. Product operation	13
7.1. Measuring principle.....	13
7.2. Functional overview	13
Display on the electronic board (PCB).....	13
Operating levels	14
8. Product design and assembly	15
8.1. Product assembly	15
9. Networking and combination with other Bürkert products	16
9.1. Networking and combination of the device.....	16
9.2. Combination of the device with available Type S020 Insertion fittings DN	16
9.3. Remote transmitters Type 8025 which can be connected to the Type 8041 flowmeter.....	16
10. Ordering information	17
10.1. Bürkert eShop.....	17
10.2. Recommendation regarding product selection.....	17
Flowmeter with G 2" process connection.....	17
Flowmeter with clamp process connection	17
10.3. Bürkert product filter.....	17

DTS 1000021534 EN Version: W Status: RL (released | freigegeben | valide) printed: 19.12.2023

10.4.	Ordering chart.....	18
	Flowmeter with G 2" process connection.....	18
	Flowmeter with clamp process connection.....	18
	Remote transmitters Type 8025 which can be connected to the Type 8041 flowmeter.....	19
10.5.	Ordering chart accessories.....	19

DTS 1000021534 EN Version: W Status: RL (released | freigegeben | validé) printed: 19.12.2023



1. General technical data

Note:

If the device is mounted in a humid environment or outside, then the maximum voltage allowed is **35 V DC** instead of 36 V DC.

Product properties

Material

Make sure the device materials are compatible with the fluid you are using.

Further information can be found in chapter [“3.1. Bürkert resistApp” on page 8.](#)

Further information on the materials can be found in chapter [“3.2. Material specifications” on page 8.](#)

Non wetted parts

Front panel film	Polyester
Cover	<ul style="list-style-type: none"> • Variant with flow sensor in PVDF: PC • Variant with flow sensor in stainless steel: back PPA (glass fibre reinforced)
Housing	<ul style="list-style-type: none"> • Variant with flow sensor in PVDF: PC (glass fibre reinforced) • Variant with flow sensor in stainless steel: back PPA (glass fibre reinforced)
Screw	Stainless steel
Union nut	<ul style="list-style-type: none"> • Variant with flow sensor in PVDF: PC • Variant with flow sensor in stainless steel: back PPA (glass fibre reinforced)
Mounting ring	Polysulphone, glass fibre reinforced
Seal	NBR
Armature	Stainless steel 1.4404/316L (for flowmeter with clamp process connection, over the clamp)
Cable gland	PA with neoprene seal

Wetted parts

Clamp connection	Stainless steel 1.4404/316L
Sensor armature	<ul style="list-style-type: none"> • PVDF • Stainless steel 1.4404/316L
Electrode holder	Only with variant with flow sensor in stainless steel: PEEK (conform to FDA)
Electrode	<ul style="list-style-type: none"> • Stainless steel 1.4404/316L • Alloy C22
Earth ring	Only with variant with flow sensor in PVDF: <ul style="list-style-type: none"> • Stainless steel 1.4404/316L • Alloy C22
Seal	<ul style="list-style-type: none"> • For flowmeter with G 2" process connection: <ul style="list-style-type: none"> – FKM (approved FDA) – EPDM (conform to FDA) • For flowmeter with clamp process connection: <p>(to be ordered separately, further information can be found in chapter “10.5. Ordering chart accessories” on page 19.)</p> <ul style="list-style-type: none"> – EPDM – FEP
Surface quality	For flowmeter with clamp process connection: Ra < 0.8 µm
Compatibility	<ul style="list-style-type: none"> • For flowmeter with G 2" process connection: Any pipe from DN 06...DN 400 which is fitted with Bürkert Type S020 Insertion fitting with G 2" sensor connection. • For flowmeter with clamp process connection: Any pipe from DN 32...DN 100 which is fitted with Bürkert Type S020 Insertion fitting with clamp sensor connection. For the selection of the nominal diameter of the Insertion fittings, see data sheet Type S020 ▶ .
Pipe diameter	<ul style="list-style-type: none"> • For flowmeter with G 2" process connection: DN 06...DN 400 • For flowmeter with clamp process connection: DN 32...DN 100
Dimensions	Further information can be found in chapter “4. Dimensions” on page 9.
Measuring element	Electrodes
Measuring principle	Electromagnetic
Measuring range	<ul style="list-style-type: none"> • Flow rate: 0.4...75000 l/min • Flow velocity: 0.2...10 m/s

Performance data	
Measurement deviation	<ul style="list-style-type: none"> Teach-In: $\pm 0.5\%$ of the measured value¹⁾ at Teach-In flow rate value Standard K-factor: $\pm 3.5\%$ of the measured value¹⁾
Linearity	$\pm 0.5\%$ of full scale ¹⁾
Repeatability	$\pm 0.25\%$ of the measured value ¹⁾
4...20 mA output uncertainty	$\pm 1\%$ of range
Electrical data	
Operating voltage	18...36 V DC $\pm 0.5\%$, filtered and regulated (3 wires)
Power source (not supplied)	Limited power source according to UL/EN 62368-1 standards or limited energy circuit according to UL/EN 61010-1 §9.4
DC reverse polarity protection	Yes
Current consumption	≤ 220 mA (at 18 V DC)
Output	<ul style="list-style-type: none"> Frequency: <ul style="list-style-type: none"> 0...240 Hz Duty cycle (pulse duration/period) = $50\% \pm 1\%$ 100 mA max. Protected against short-circuits and polarity reversals Relay: <ul style="list-style-type: none"> Normally open or normally closed (depending on wiring) Non UL recognized device: 250 V AC/3 A or 40 V DC/3 A (resistive load) UL recognized device: 30 V AC/42 V_{peak}/3 A or 60 V DC/1 A Current: <ul style="list-style-type: none"> 4...20 mA Sink or source (by wiring) 100 ms refresh time Max. loop impedance: 1100 Ω at 36 V DC; 330 Ω at 18 V DC
Fault signal	<ul style="list-style-type: none"> Full scale exceeding: 22 mA and 256 Hz Fault signalling: 22 mA and 0 Hz
Voltage supply cable	<ul style="list-style-type: none"> Shielded External diameter (cable): 6...12 mm (1 cable per cable gland) or 4...5 mm when using a multi-way seal (2 cables per cable gland) Cross section of wires: 0.5...1.5 mm²
Medium data	
Fluid temperature	<ul style="list-style-type: none"> Variant with flow sensor in PVDF: 0...+80 °C (+32...+176 °F) (depends on Insertion fitting) Variant with flow sensor in stainless steel: -15...+150 °C (+5...+302 °F) (depends on Insertion fitting) <p>Further information can be found in chapter "5.1. Pressure temperature diagram" on page 11 and in the data sheet of the Insertion fitting, see data sheet Type S020 ▶.</p>
Fluid pressure	<ul style="list-style-type: none"> Variant with flow sensor in PVDF: max. PN 10 (145.1 PSI) Variant with flow sensor in stainless steel: <ul style="list-style-type: none"> Max. PN 10 (145.1 PSI) (with plastic Insertion fitting) Max. PN 16 (232.16 PSI) (with metal Insertion fitting) <p>Further information can be found in chapter "5.1. Pressure temperature diagram" on page 11 and in the data sheet of the Insertion fitting, see data sheet Type S020 ▶.</p>
Viscosity	<1000 mPa.s
Minimum conductivity	20 μ S/cm
Process/Pipe connection & communication	
Process connection	<ul style="list-style-type: none"> G 2" for use with Type S020 Insertion fitting Clamp for use with Type S020 Insertion fitting or any pipe equipped with our clamp sensor connection <p>See data sheet Type S020 ▶ for more information.</p>
Electrical connection	2 cable glands M20 x 1.5
User parameter	Saved in EEPROM

Approvals and conformities

Directives

CE directive	Further information on the CE Directive can be found in chapter “2.3. Standards” on page 7.
Pressure equipment directive	Complying with article 4, paragraph 1 of 2014/68/EU directive Further information on the pressure equipment directive can be found in chapter “2.4. Pressure Equipment Directive (PED)” on page 7.
North America (USA/Canada) Foods and beverages/Hygiene	UL Recognized for the USA and Canada <ul style="list-style-type: none"> • FDA declaration of conformity (only for stainless steel or PVDF sensor with FKM or EPDM seals) • ECR1935/2004 declaration (only for stainless steel sensor with EPDM seals)

Environment and installation

Ambient temperature	<ul style="list-style-type: none"> • Operation: -10...+60 °C (+14...+140 °F) • Storage: -20...+60 °C (-4...+140 °F)
Relative air humidity	≤80 %, without condensation
Height above sea level	Max. 2000 m
Operating condition	Continuous
Equipment mobility	Fixed
Application range	Indoor and outdoor Protect the device against electromagnetic interference, ultraviolet rays and, when installed outdoors, against the effects of climatic conditions.
Degree of protection ^{2.)} according to IEC/EN 60529	IP65 with the following conditions met: <ul style="list-style-type: none"> • device wired • cover screwed tight • cable glands mounted and tightened • with blind plug on unused cable glands
Installation category	Category I according to UL/EN 61010-1
Pollution degree	Degree 2 according to UL/EN 61010-1

1.) Under reference conditions i.e. measuring medium = water, ambient and water temperature = +20 °C (+68 °F), observing the minimum the minimum inlet and outlet sections and the appropriate inner diameter of the pipe.

2.) Not evaluated by UL

DTS 1000021534 EN Version: W Status: RL (released | freigegeben | validé) printed: 19.12.2023

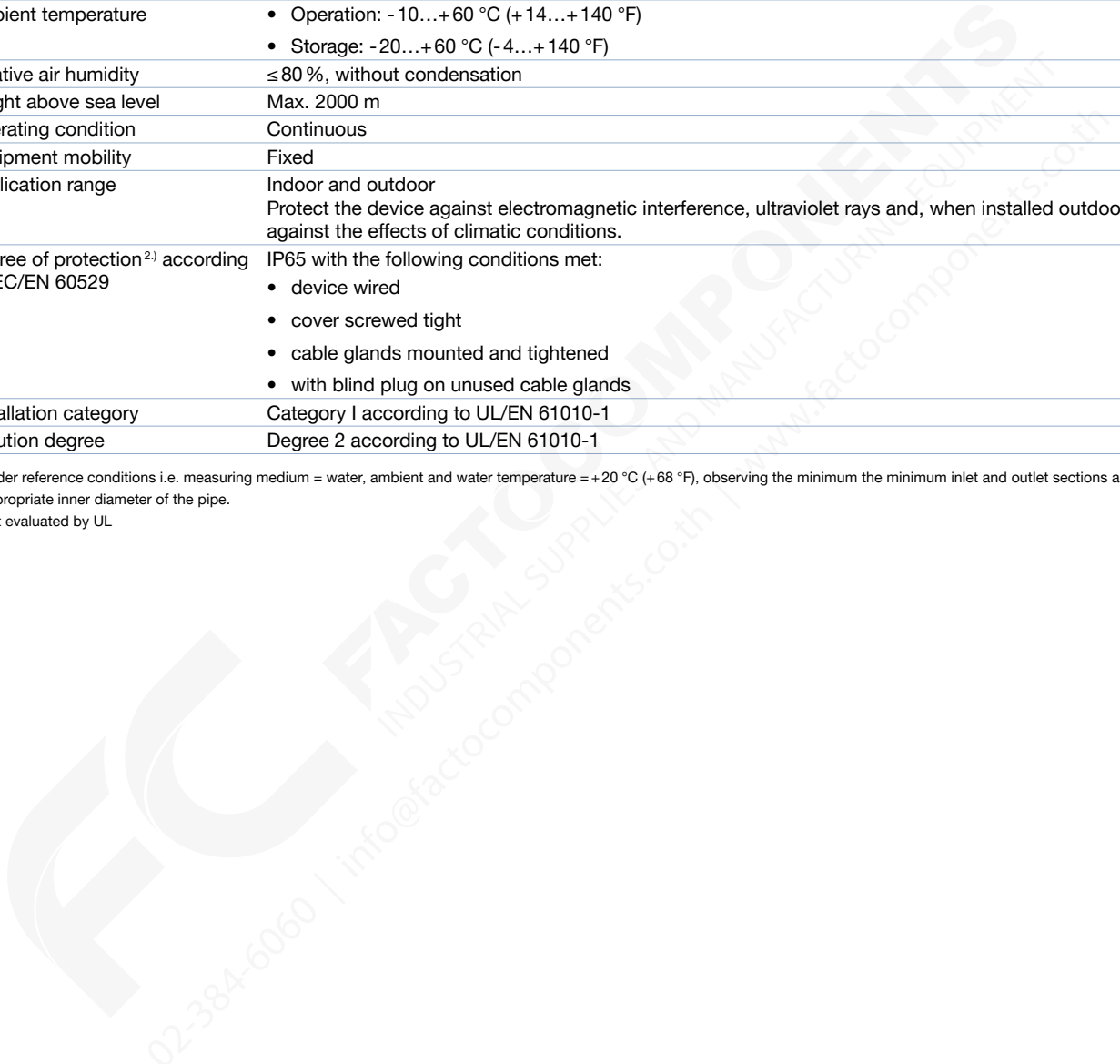

2. Approvals and conformities

2.1. General notes

- The approvals and conformities listed below must be stated when making enquiries. This is the only way to ensure that the product complies with all required specifications.
- Not all available variants of the device can be supplied with the below mentioned approvals or conformities.

2.2. Conformity

In accordance with the Declaration of Conformity, the product is compliant with the EU Directives.

2.3. Standards

The applied standards which are used to demonstrate compliance with the EU Directives are listed in the EU-Type Examination Certificate and/or the EU Declaration of Conformity.

2.4. Pressure Equipment Directive (PED)

The device conforms to article 4, paragraph 1 of the Pressure Equipment Directive (PED) 2014/68/EU under the following conditions:

Device used on a pipe

Note:

- The data in the table is independent of the chemical compatibility of the material and the fluid.
- PS = maximum admissible pressure (in bar), DN = nominal diameter of the pipe

Type of fluid	Conditions
Fluid group 1, article 4, paragraph 1.c.i	DN ≤ 25
Fluid group 2, article 4, paragraph 1.c.i	DN ≤ 32 or PS*DN ≤ 1000
Fluid group 1, article 4, paragraph 1.c.ii	DN ≤ 25 or PS*DN ≤ 2000
Fluid group 2, article 4, paragraph 1.c.ii	DN ≤ 200 or PS ≤ 10 or PS*DN ≤ 5000

2.5. North America (USA/Canada)

Approval	Description
	Optional: UL Recognized for the USA and Canada The products are UL Recognized for the USA and Canada according to: <ul style="list-style-type: none"> • UL 61010-1 • CAN/CSA-C22.2 No. 61010-1

2.6. Foods and beverages/Hygiene

Conformity	Description
FDA	FDA – Code of Federal Regulations (valid for the variable code PL02, PL03) Only devices with stainless steel or PVDF sensor and FKM or EPDM seals are compliant with the Code of Federal Regulations published by the FDA (Food and Drug Administration, USA) according to the manufacturer’s declaration.
	EC Regulation 1935/2004 of the European Parliament and of the Council (valid for the variable code PL01, PL02) Only devices with stainless steel sensor and EPDM seals are compliant with EC Regulation 1935/2004/EC according to the manufacturer’s declaration.

DTS 1000021534 EN Version: W Status: RL (released | freigegeben | validé) printed: 19.12.2023

3. Materials

3.1. Bürkert resistApp

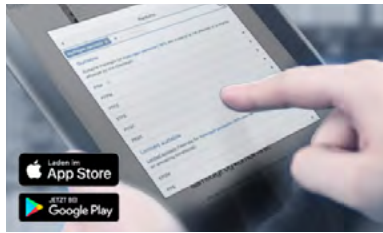

Bürkert resistApp – Chemical resistance chart

You want to ensure the reliability and durability of the materials in your individual application case? Verify your combination of media and materials on our website or in our resistApp.

[Start chemical resistance check](#)

3.2. Material specifications

Flowmeter with

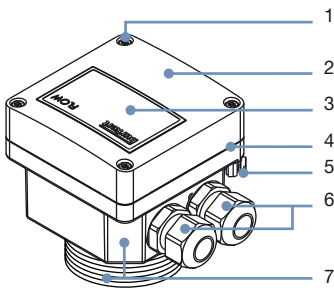

- G 2" process connection and sensor holder in PVDF or

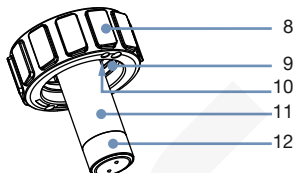

- G 2" process connection and sensor holder in stainless steel or

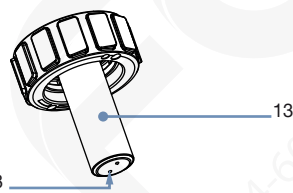

- Clamp process connection and with sensor holder in stainless steel



No.	Element	Material
1	Screws	Stainless steel
2	Cover	<ul style="list-style-type: none"> PC for variant with flow sensor in PVDF Black PPA, glass fibre reinforced for variant with flow sensor in stainless steel
3	Front panel foil	Polyester
4	Seal	NBR
5	Screw	Stainless steel
6	Cable glands	PA with neoprene seal
7	Housing	<ul style="list-style-type: none"> PC, glass fibre reinforced for variant with flow sensor in PVDF Black PPA, glass fibre reinforced for variant with flow sensor in stainless steel
8	Nut	<ul style="list-style-type: none"> PC for variant with flow sensor in PVDF PPA glass fibre reinforced for variant with flow sensor in stainless steel
9	Mounting ring (open)	Polysulphone, glass fibre reinforced
10	Seals	<ul style="list-style-type: none"> FKM (approved FDA) EPDM included, but not mounted (conform to FDA)
11	Sensor holder	PVDF
12	Earth ring	<ul style="list-style-type: none"> Stainless steel 1.4404/316L or Alloy C22
13	Sensor holder	Stainless steel 1.4404/316L
14	Holder	Stainless steel 1.4404/316L
15	Clamp connection	Stainless steel 1.4404/316L
16	Sensor holder	Stainless steel 1.4404/316L
17	Electrode holder	PEEK (conform to FDA)
18	Electrodes	<ul style="list-style-type: none"> Stainless steel 1.4404/316L or Alloy C22

DTS 1000021534 EN Version: W Status: RL (released | freigegeben | validé) printed: 19.12.2023

4. Dimensions

4.1. Flowmeter

With G 2" process connection

Note:

- Dimensions in mm, unless otherwise stated
- The length of the flow probe depends on the used Insertion fitting Type S020 and its nominal diameter.

See **data sheet Type S020** ▶ for more information or chapter **“9.2. Combination of the device with available Type S020 Insertion fittings DN”** on page 16.

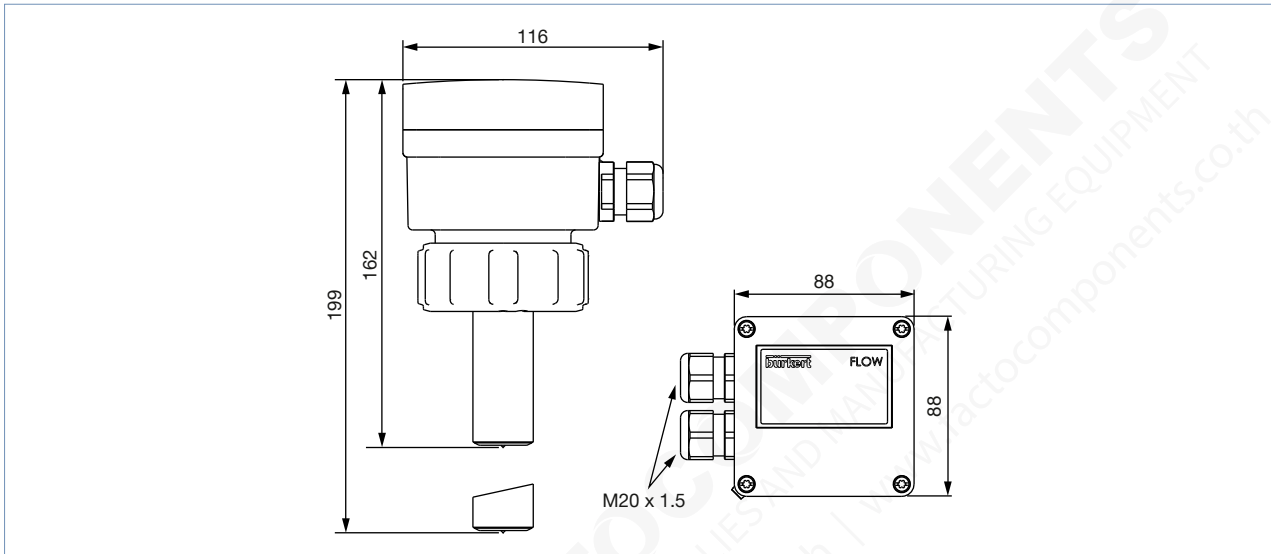

With clamp process connection

Note:

Dimensions in mm, unless otherwise stated

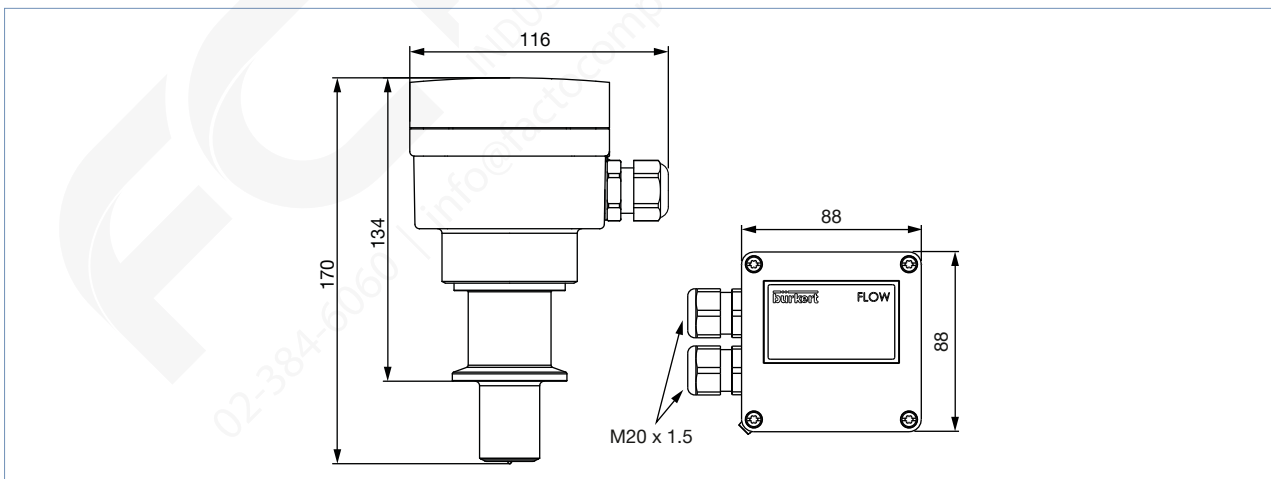

4.2. Flowmeter installed in an Insertion fitting Type S020

With G 2" process connection

Note:

Dimensions in mm, unless otherwise stated

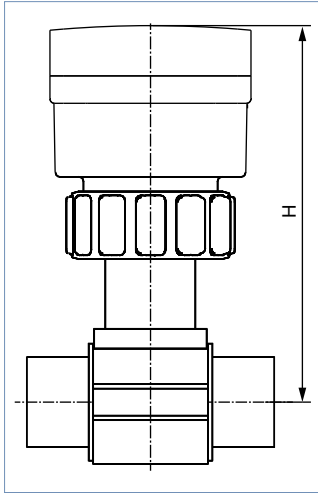

DN	H			
	T-Fitting	Saddle	Plastic spigot	Metal spigot
06	163	-	-	-
08	163	-	-	-
15	168	-	-	-
20	166	-	-	-
25	166	-	-	-
32	169	-	-	-
40	173	-	-	169
50	179	204	-	174
65	179	203	187	180
80	-	207	193	185
100	-	212	200	195
110	-	208	-	-
125	-	215	235	206
150	-	225	242	217
180	-	249	-	-
200	-	261	263	238
250	-	-	281	298
300	-	-	293	317
350	-	-	306	329
400	-	-	321	-

With clamp process connection

Note:

Dimensions in mm, unless otherwise stated

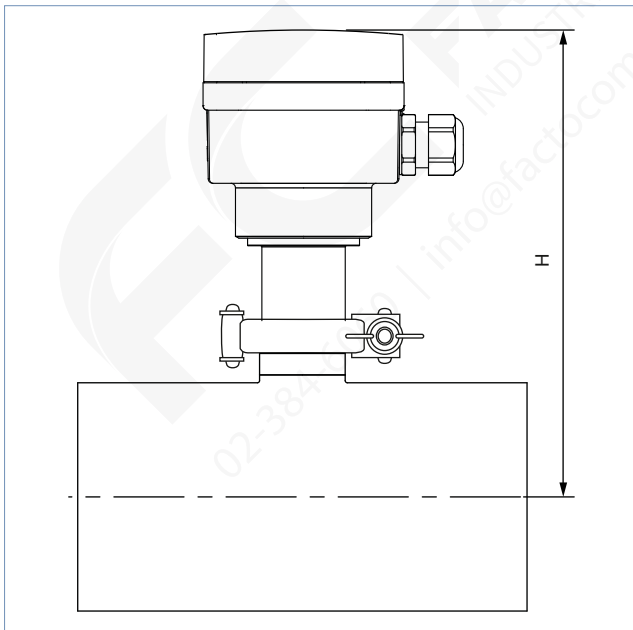

DN	H
	T-Fitting
32	181
40	186
50	191
65	199
80	205
100	211

DTS 1000021534 EN Version: W Status: RL (released | valide) | freigegeben | validé | printed: 19.12.2023

5. Performance specifications

5.1. Pressure temperature diagram

Flowmeter with a PVDF sensor

Note:

Take into account the dependence between fluid pressure and temperature according to the fitting and flowmeter material shown in the following diagram.

See **data sheet Type S020** ▶ for more information.

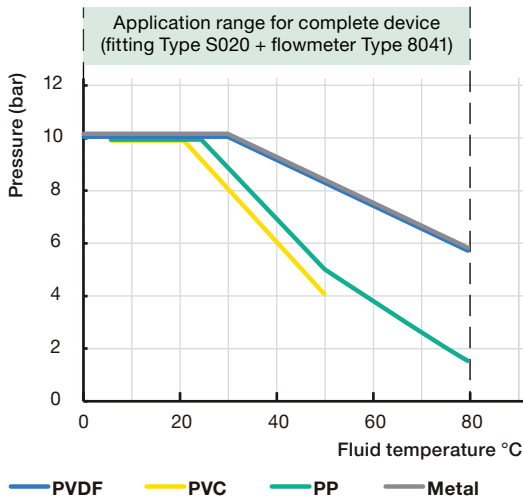

Flowmeter with a stainless steel sensor

Note:

Take into account the dependence between fluid pressure and temperature according to the fitting and flowmeter material shown in the following diagram.

See **data sheet Type S020** ▶ for more information.

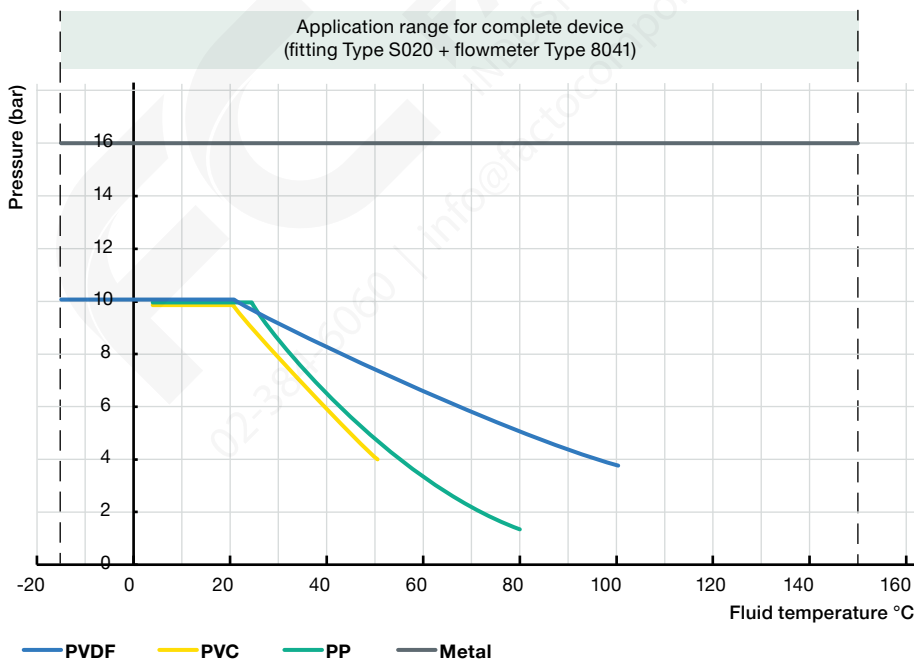

6. Product installation

6.1. Installation notes

Note:

The device is not suitable for use in gaseous media and steam.

Minimum straight distances upstream and downstream of the sensor must be observed. These stabilizing distances depend on the pipe's design. Increasing these distances or installing a flow conditioner may be necessary to obtain the best accuracy. For more information, refer to EN ISO 5167-1.

EN ISO 5167-1 specifies the straight inlet and outlet distances that must be complied with when installing fittings in pipe lines in order to achieve calm flow conditions. The most commonly used elements that could lead to turbulence in the flow are shown below. The related minimum inlet and outlet distances that ensure a calm flow are also specified.

Make sure that the measuring conditions at the point of measurement are calm and problem-free.

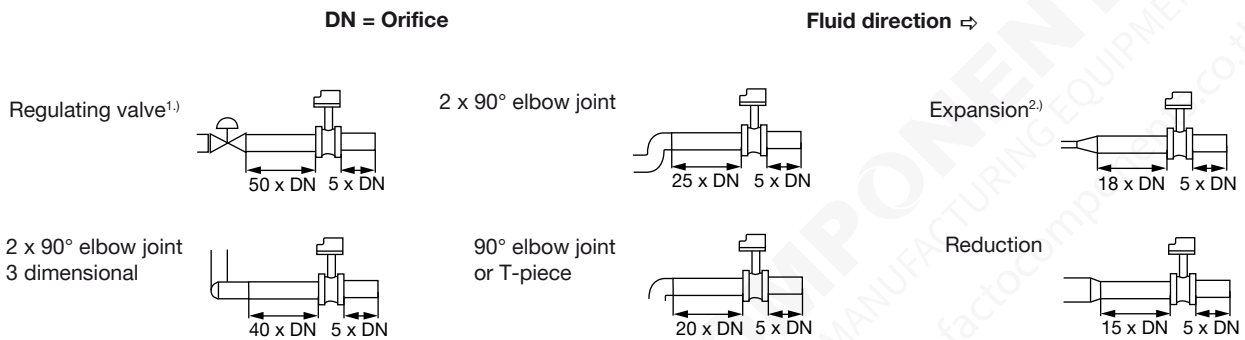

- 1.) If the valve cannot be mounted after the measuring device, the minimal distances have to be respected.
 - 2.) If an expansion cannot be avoided, the minimal distances have to be respected.
- Please note minimum flow velocity

The device can be installed in either horizontal or vertical pipes, but following additional conditions should be respected:

- The pipe always has to be filled with fluid at all times near the device.
- The pipe design must be such that no air bubbles or cavitation can form within the medium near the device at any time.

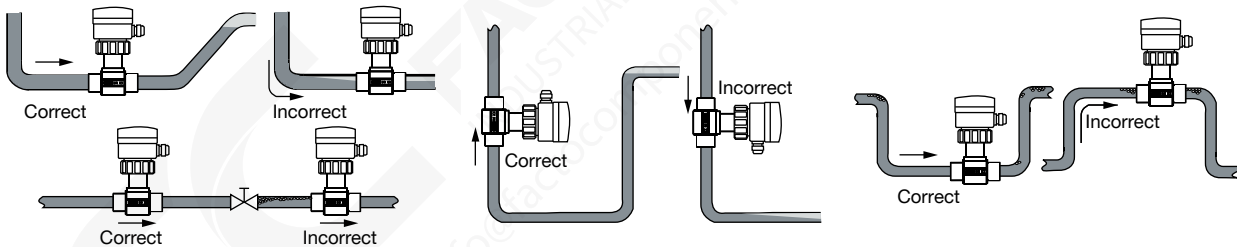

Pressure and temperature ratings must be respected according to the selected fitting material. The suitable pipe size is selected using the diagram in the chapter "Nominal size selection" of the **data sheet Type S020**.

6.2. Mounting options

It is advisable to mount the flowmeter at a 45° angle to the horizontal centre of the pipe to avoid having deposits on the electrodes and false measurements due to air bubbles

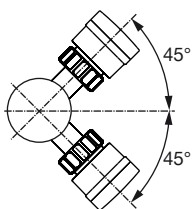

DTS 1000021534 EN Version: W Status: RL (released | valide) | freigegeben | printed: 19.12.2023

7. Product operation

7.1. Measuring principle

The E-shaped magnetic system inside the sensor induces a magnetic field into the fluid, which is perpendicular to the direction of flow. Two electrodes are in galvanic contact with the liquid.

Based on the Faraday law a voltage can be measured between these electrodes once a liquid (min. conductivity of 20 µS/cm) flows along the pipe. This voltage is proportional to the flow velocity.

Using the K-factor for the individual pipe diameter the speed of flow is converted into volume per time.

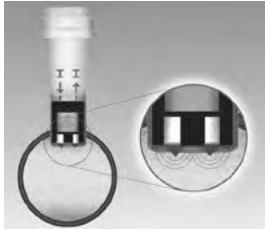

7.2. Functional overview

Display on the electronic board (PCB)

The settings needed for operation are made directly on the printed circuit board by means of 5 switches, a push button, a green LED, a red LED and a bar graph.

Electronic board of the device	No.	Description
	1	Terminal strip: <ul style="list-style-type: none"> Operating voltage 4...20 mA output Frequency output
	2	Relay connection
	3	Push-button
	4	Green LED: <ul style="list-style-type: none"> Flashing once every second: the device is energized. Flashing once up to 5 times: to know which parameter the bargraph is indicating.
	5	Red LED: <ul style="list-style-type: none"> Working mode (ON/OFF) Error signalling (flashing once up to 5 times)
	6	10 LED bar graph to view and set the device parameters
	7	<ul style="list-style-type: none"> Switches 1 to 5 to configure the flowmeter (mains frequency, filtering level of the measurements, measuring range) Switch 6: unused

The device can be calibrated by means of the K-factor (conversion coefficient), or via the Teach-In function.

Operating levels

The device has 2 operating levels:

- The Read level
- The Configuration level

Operating level	Functions
Read	This level allows to read: <ul style="list-style-type: none"> • the fluid velocity measured by the device. • the values set for the relay function.
Configuration	This level allows to set the required operation parameters: <ul style="list-style-type: none"> • Device using as a flowmeter <ul style="list-style-type: none"> – programming of the full scale <ul style="list-style-type: none"> – selection of a predefined measuring range: 0...2, 0...5 or 0...10 m/s – selection by Teach-In: with the actual max. flow velocity of the application – 4...20 mA current output – 0...240 Hz frequency output – relay output: switching mode either window or hysteresis, on low or high switching threshold – relay time delay before switching – filter – alarm: <ul style="list-style-type: none"> – for full scale exceeding with 22 mA and 256 Hz – for fault signalling with 22 mA and 0 Hz • Device using an ON/OFF control <ul style="list-style-type: none"> – flow detection with switching thresholds, defined as a percentage of max. flow rate. – adjustment of the full scale of the device accordingly to the customer process full scale.

DTS 1000021534 EN Version: W Status: RL (released | freigegeben | validé) printed: 19.12.2023

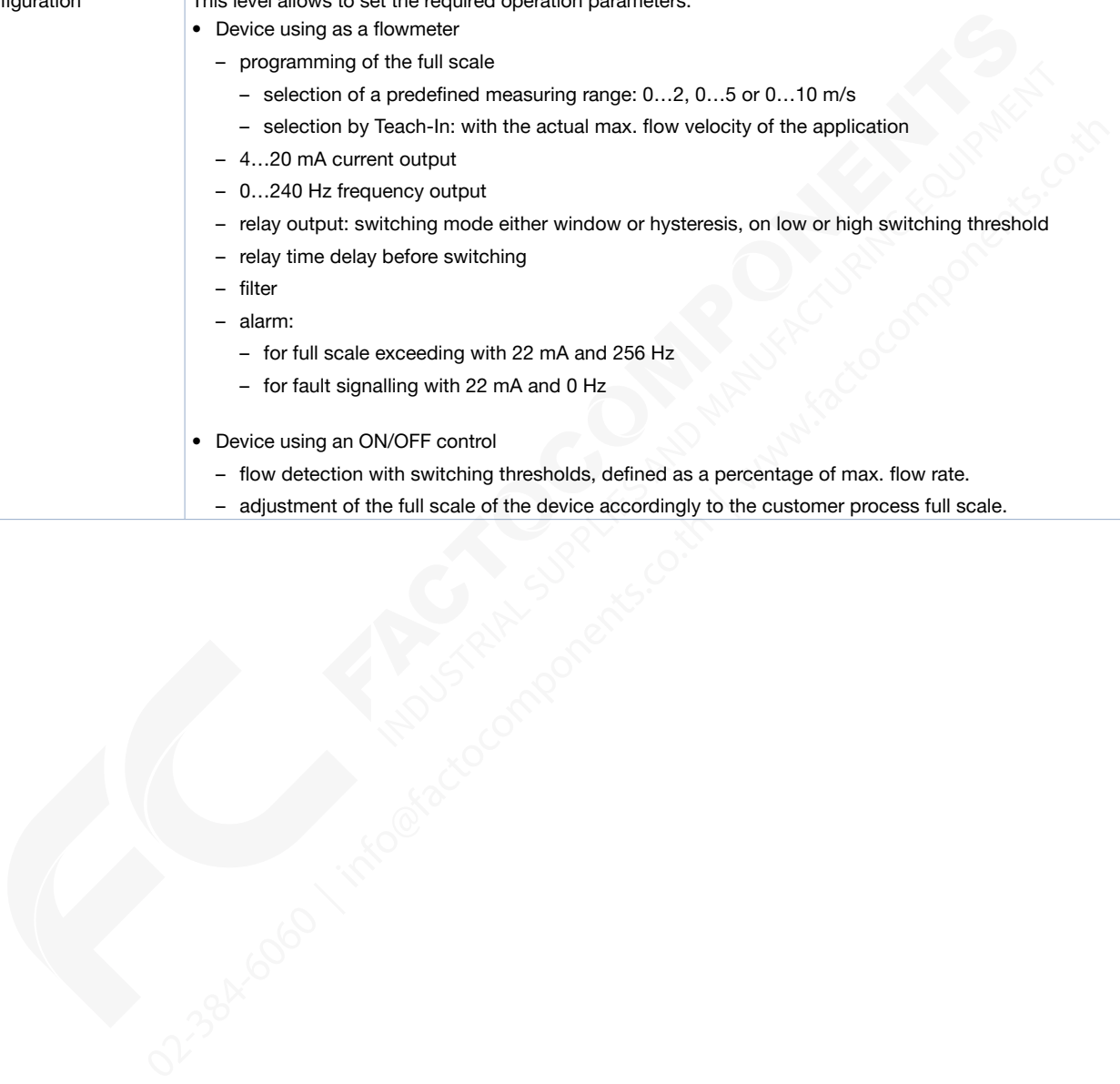

8. Product design and assembly

8.1. Product assembly

Note:

- The device Type 8041 is installed into a Bürkert Insertion fitting Type S020 and fastened with a union nut.
- The Insertion fitting Type S020 ensures simple installation into pipes from DN 06...DN 400, see **data sheet Type S020** ▶ for more information.

The device is equipped with a PVDF or stainless steel measurement sensor which comprises two electrodes and a magnetic system and is available in long or short variant (dependent on the size of the used fitting). The sensor holder is plugged-in to the housing, which contains containing the electronic module.

The connection of the device to the process is made depending on the variant, either by a G 2" nut or a clamp.

The electrical connection is provided via two cable glands on a 6-pin terminal block.

Compact flowmeter with a G 2" process connection



Insertion fitting with a G 2" sensor connection Type S020



Complete device with a G 2" process connection for flow measurement Type 8041

Fitting in stainless steel with a G 2" sensor connection Type S020 (only example)

Compact flowmeter with a clamp process connection

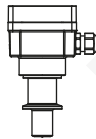

Clamp collar and seal (accessories, to be ordered separately)



Insertion fitting with a clamp sensor connection Type S020

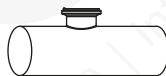

Complete device with a clamp process connection for flow measurement Type 8041

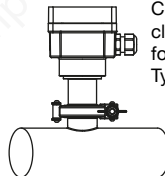

DTS 1000021534 EN Version: W Status: RL (released | freigegeben | validé) printed: 19.12.2023

9. Networking and combination with other Bürkert products

9.1. Networking and combination of the device

Example:

9.2. Combination of the device with available Type S020 Insertion fittings DN

Fitting with G 2" process connection		DN06	DN08	DN32	DN50	DN65	DN100	DN200	DN350	DN400
Available S020 fittings DN	T-fitting	1.)		short sensor						
	Welding socket				short sensor			long sensor		
	Fusion spigot					short sensor	long sensor			
	Screw-on spigot						long sensor			
	Saddle				long sensor					
Fitting with clamp process connection										
	T-fitting or welding socket									

1.) DN06 and DN08: S020 in stainless steel only and 8041 with stainless steel sensor recommended

9.3. Remote transmitters Type 8025 which can be connected to the Type 8041 flowmeter

A remote electronic Type 8025 can be connected to the flowmeter Type 8041. For the selection of the article, see chapter [“Remote transmitters Type 8025 which can be connected to the Type 8041 flowmeter”](#) on page 19.

DTS 1000021534 EN Version: W Status: RL (released | freigegeben | validé) printed: 19.12.2023

10. Ordering information

10.1. Bürkert eShop



Bürkert eShop – Easy ordering and quick delivery

You want to find your desired Bürkert product or spare part quickly and order directly? Our online shop is available for you 24/7. Sign up and enjoy all the benefits.

[Order online now](#)

10.2. Recommendation regarding product selection

Flowmeter with G 2" process connection

A complete 8041 flowmeter consists of a 8041 flowmeter with G 2" process connection and a Bürkert Type S020 Insertion fitting with G 2" sensor connection .

See [data sheet Type S020](#) ▶ for more information.

Two different components must be ordered in order to select a complete device. The following information is required:

- **Article no.** of the desired compact flowmeter with G 2" process connection Type 8041 (see chapter "[Flowmeter with G 2" process connection](#)" on page 18)
- **Article no.** of the selected Type S020 Insertion fitting with G 2" sensor connection (see [data sheet Type S020](#) ▶)

Flowmeter with clamp process connection

A complete 8041 flowmeter consists of a 8041 flowmeter with clamp process connection and a Bürkert Type S020 Insertion fitting with clamp sensor connection .

See [data sheet Type S020](#) ▶ for more information.

Four different components must be ordered in order to select a complete device. The following information is required:

- **Article no.** of the desired flowmeter with clamp process connection Type 8041(see chapter "[Flowmeter with clamp process connection](#)" on page 18)
- **Article no.** of the selected Type S020 Insertion fitting with clamp sensor connection (see [data sheet Type S020](#) ▶)
- **Article no.** of the selected fitting/flowmeter seal, in EPDM or FEP (see chapter "[10.5. Ordering chart accessories](#)" on page 19)
- **Article no.** of the clamp collar (see chapter "[10.5. Ordering chart accessories](#)" on page 19)

10.3. Bürkert product filter



Bürkert product filter – Get quickly to the right product

You want to select products comfortably based on your technical requirements? Use the Bürkert product filter and find suitable articles for your application quickly and easily.

[Try out our product filter](#)

10.4. Ordering chart

Flowmeter with G 2" process connection

Note:

The following variants

- have at least
 - a FKM process seal
 - an 18...36 V DC operating voltage
- are supplied with an accessories set (article no. 551775) including an EPDM seal and with a relay connection set (article no. 552812).

Further information regarding the sets can be found in chapter **“10.5. Ordering chart accessories”** on page 19.

Sensor variant	Output	Material		Approval and conformity			Electrical connection	Article no.
		Housing	Sensor / Earth ring / Electrode	UL	FDA	ECR1935/2004 ¹⁾		
Short	Frequency, relay and 4...20 mA	PC	PVDF / Stainless steel / Stainless steel	–	Yes	–	2 cable glands M20 x 1.5	558064
Long				UL Recognized				570482
				–	558065			
Short				UL Recognized	570483			
		–	560751					
Long		PVDF / Alloy C22 / Alloy C22	–	–	560752			
Short	PPA	Stainless steel / – / Stainless steel	–	Yes	Yes	552779		
			UL Recognized			561606		
			–	552780				
			UL Recognized	561607				

1.) Only if the FKM seal mounted as standard at factory is replaced with the EPDM seal included in the delivery.

Flowmeter with clamp process connection

Note:

The following variants

- have at least an 18...36 V DC operating voltage
- are supplied with an accessories set (article no. 565384) and with a relay connection set (article no. 552812).

Further information regarding the sets can be found in chapter **“10.5. Ordering chart accessories”** on page 19.







Output	Material			Approval and conformity		Electrical connection	Article no.
	Housing	Sensor / Electrode	Fitting/flowmeter seals ¹⁾	FDA	ECR1935/2004 ²⁾		
Frequency, relay and 4...20 mA	PC	Stainless steel / Stainless steel	EPDM or FEP	Yes	–	2 cable glands M20 x 1.5	564688

1.) Has to be ordered separately.















2.) Only for mounting with EPDM seal

DTS 1000021534 EN Version: W Status: RL (released | freigegeben | valide) printed: 19.12.2023

Remote transmitters Type 8025 which can be connected to the Type 8041 flowmeter

Description	Operating voltage	Output	Relay	Electrical connection	Article no.
Panel-mounted variant					
"Universal", 2 totalizers	18...30 V DC	4...20 mA, pulse	–	Terminal strip	419538 
			2		419537 
"Batch", 2 totalizers, 1 flowrate		–			419536 
Wall-mounted variant					
"Universal", 2 totalizers	18...30 V DC	4...20 mA, pulse	–	3 cable glands	419541 
			2		419540 
	115...230 V DC		–		419544 
"Batch", 2 totalizers, 1 flowrate	18...30 V DC	–	2	5 cable glands	433740 

10.5. Ordering chart accessories

Description	Article no.
For flowmeter with G 2" or clamp process connection	
Set with two cable glands M20 × 1.5, two neoprene flat seals for cable gland or plug, two screw plugs M20 × 1.5 and two multi-way seals 2 × 6 mm	449755 
Set with two adaptors M20 × 1.5 /NPT ½", two neoprene flat seals for cable gland or plug and two screw plugs M20 × 1.5	551782 
Relay connection set with a terminal strip, a protective cap, a cable tie and a mounting instruction sheet	552812 
3-point flow calibration certificate ^{1.)}	550676 
FDA declaration of conformity ^{2.)}	803724 
For flowmeter with G 2" process connection	
Set with a stopper for unused cable gland M20 × 1.5, a multiway seal 2 × 6 mm for cable gland, a green FKM seal for the sensor and a mounting instruction sheet	558102 
Set with a green FKM seal and a black EPDM seal	552111 
Fastening ring (open) for Type S020 Insertion fitting	619205 
PC union nut for Type S020 Insertion fitting	619204 
PPA union nut for Type S020 Insertion fitting	440229 
For flowmeter with clamp process connection	
Set with a stopper for unused cable gland M20 × 1.5 and a multiway seal 2 × 6 mm for cable gland	565384 
1 EPDM fitting/flowmeter seal	730837 
1 FEP fitting/flowmeter seal	730839 
Clamp collar	731164 

1.) Measuring device in combination with a Type S020 Insertion fitting, only for DN ≤ 200

2.) For stainless steel or PVDF sensor with FKM or EPDM seal