

# RV Series Air Control valve (5/2, 5/3 way)

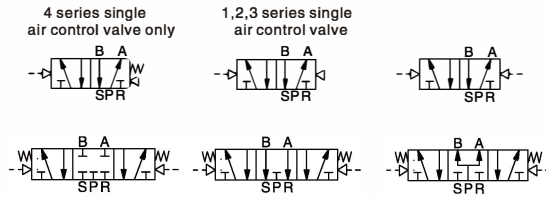

## RV

### Air Control Valve(5/2,5/3)



### How to Order?

| Series No/Ways | Positions | Valve Body ID Code               | Controls   | Initial Status                         | Port Size  | Reset Type  | Thread Type                 |
|----------------|-----------|----------------------------------|--|--|--|---|-----------------------------|
| RVA            | 5: 5 ways | 2: 2 positions<br>3: 3 positions | 1: 1Series<br>2: 2Series<br>3: 3Series<br>4: 4Series | 1: Single control<br>2: Double control | M5: M5<br>06: 1/8"<br>08: 1/4"<br>10: 3/8"<br>15: 1/2" | Blank: Spring return<br>(Apply to 4 series single control valve)<br>Q: Air return<br>(Apply to 1,2,3 series single control valve) | Bland: G<br>P: PT<br>T: NPT |

#### Order Example:

RV series air control valve, 5/2 way, 2 series valve body size, single control, 1/8" port size, air return, G thread, ERP code is: RVA5221-06Q

### Specifications

| Model No.                | RVA5211-M5<br>RVA5212-M5<br>RVA5312-M5  | RVA5211-06<br>RVA5212-06<br>RVA5312-06 | RVA5221-06<br>RVA5222-06<br>RVA5322-06    | RVA5221-08<br>RVA5222-08<br>RVA5322-08 | RVA5231-08<br>RVA5232-08<br>RVA5332-08    | RVA5231-10<br>RVA5232-10<br>RVA5332-10 | RVA5241-10<br>RVA5242-10<br>RVA5342-10    | RVA5241-15<br>RVA5242-15<br>RVA5342-15 |
|--------------------------|---|--|---|--|---|--|---|--|
| Port size                | M5                                      | G1/8                                   | G1/8                                      | G1/4(Ex.G1/8)                          | G1/4                                      | G3/8(Ex.G1/4)                          | G3/8                                      | G1/2                                   |
| Sectional area(mm)       | 5/2: 5.5(CV=0.31)<br>5/3: 5.5(CV=0.28)  | 5/2: 12(CV=0.67)<br>5/3: 9(CV=0.50)    | 5/2: 14(CV=0.78)<br>5/3: 12(CV=0.67)      | 5/2: 16(CV=0.89)<br>5/3: 12(CV=0.67)   | 5/2: 25(CV=1.40)<br>5/3: 18(CV=1.00)      | 5/2: 30(CV=1.68)<br>5/3: 18(CV=1.00)   | 5/2: 50(CV=2.79)<br>5/3: 30(CV=1.67)      | 5/2: 50(CV=2.79)<br>5/3: 30(CV=1.67)   |
| Working medium           | Clean air(After 40 μm filtration)       |  |   |  |   |  |   |  |
| Acting type              | External type                           |  |   |  |   |  |   |  |
| Reset type               | Air reset                               |  |   |  |   |  | Spring reset / Air reset                  |  |
| Lubrication              | Not required                            |  |   |  |   |  |   |  |
| Working pressure(MPa)    | 0.15~0.8                                |  |   |  |   |  |   |  |
| Guaranteed pressure(MPa) | 1.2                                     |  |   |  |   |  |   |  |
| Working temperature(°C)  | -20~70 ( No freezing )                  |  |   |  |   |  |   |  |
| Max. acting frequency    | 5/2: 5 Cycles/s; 5/3: 3 Cycles/s        |  |   |  |   |  |   |  |
| Weight(g)                | RVA5211:72<br>RVA5212:87<br>RVA5312:181 |  | RVA5221:128<br>RVA5222:153<br>RVA5322:219 |  | RVA5231:218<br>RVA5232:260<br>RVA5332:358 |  | RVA5241:437<br>RVA5242:490<br>RVA5342:598 |  |

### Internal Structure

#### Single Air Control

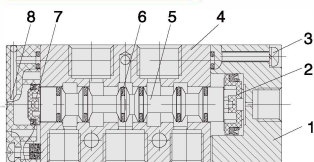

#### Double Air Control

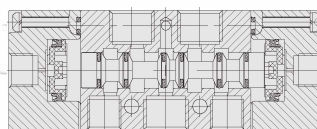

#### 5/3 Ways Solenoid Valve

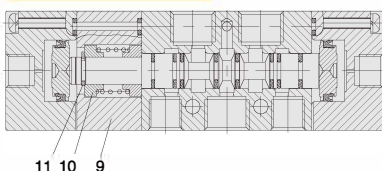

| No. | Part Name         | Material       |
|-----|-------------------|----------------|
| 1   | Air Control Cover | Aluminum Alloy |
| 2   | Piston            | POM            |
| 3   | Screw             | Carbon Steel   |
| 4   | Valve Body        | Aluminum Alloy |
| 5   | Spool             | Aluminum Alloy |
| 6   | O-ring            | NBR            |
| 7   | Piston            | POM            |
| 8   | Rear Cover        | Zinc Alloy     |
| 9   | Back Seat         | Aluminum Alloy |
| 10  | Spring Seat       | Aluminum Alloy |
| 11  | C-type Buckle     | 65Mn           |

# RV Series Air Control valve (5/2, 5/3 way)



## Flow Chart

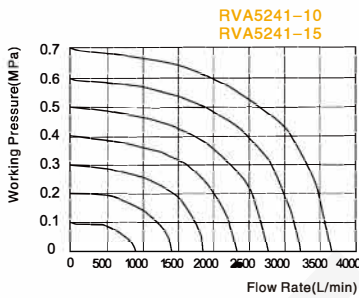
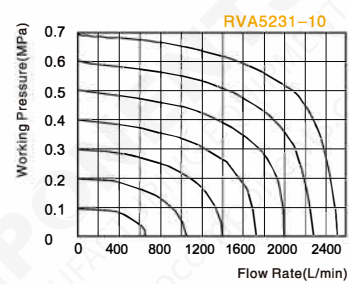
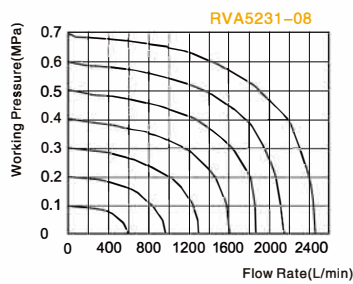
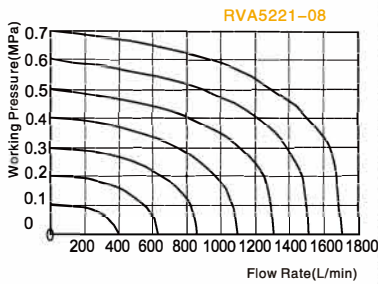
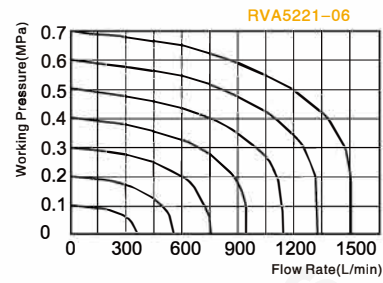
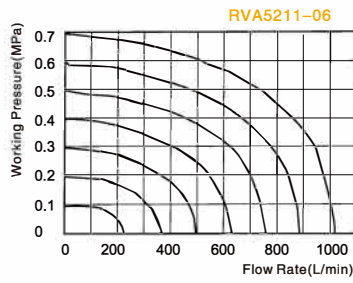
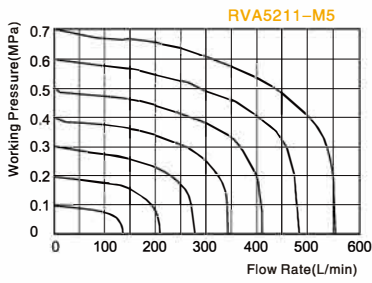

## Main Dimension

Single Air Control

Double Air Control

5/3 Ways Solenoid Valve

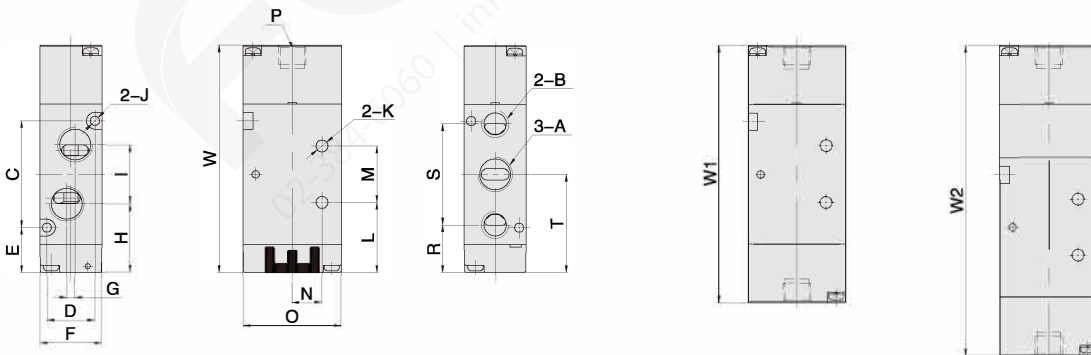

| Model\Sign | A    | B    | C  | D  | E    | F  | G | H    | I    | J   | K   | L    | M  | N    | O  | P    | R    | S    | T    | W    | W1  | W2  |
|------------|------|------|----|----|------|----|---|------|------|-----|-----|------|----|------|----|------|------|------|------|------|-----|-----|
| RVA5211-M5 | M5   | M5   | 30 | 13 | 16.5 | 18 | 0 | 24.5 | 14.1 | 3.3 | 3.3 | 24.5 | 14 | 9.5  | 27 | G1/8 | 17.9 | 27.2 | 31.5 | 72   | 81  | 96  |
| RVA5211-06 | G1/8 | G1/8 | 30 | 13 | 16.5 | 18 | 3 | 23.5 | 16   | 3.3 | 3.3 | 24.5 | 14 | 9.5  | 27 | G1/8 | 17.5 | 28   | 31.5 | 72   | 81  | 96  |
| RVA5221-06 | G1/8 | G1/8 | 38 | 17 | 16   | 22 | 0 | 26   | 18   | 3.3 | 4.3 | 25   | 20 | 10.5 | 35 | G1/8 | 17   | 36   | 35   | 81   | 92  | 111 |
| RVA5221-08 | G1/4 | G1/8 | 38 | 17 | 16   | 22 | 3 | 24.5 | 21   | 3.3 | 4.3 | 25   | 20 | 10.5 | 35 | G1/8 | 17   | 36   | 35   | 81   | 92  | 111 |
| RVA5231-08 | G1/4 | G1/4 | 50 | 20 | 19.1 | 27 | 0 | 33.1 | 22   | 4.3 | 4.3 | 32.1 | 24 | 13.5 | 40 | G1/8 | 21.6 | 45   | 44.1 | 99.6 | 111 | 130 |
| RVA5231-10 | G3/8 | G1/4 | 50 | 20 | 19.1 | 27 | 4 | 32.1 | 24   | 4.3 | 4.3 | 32.1 | 24 | 13.5 | 40 | G1/8 | 21.6 | 45   | 44.1 | 99.6 | 111 | 130 |
| RVA5241-10 | G3/8 | G3/8 | 72 | 27 | 21   | 34 | 0 | 39   | 36   | 4.3 | 5.2 | 43   | 28 | 17.5 | 50 | G1/8 | 25.5 | 63   | 57   | 127  | 140 | 161 |
| RVA5241-15 | G1/2 | G1/2 | 72 | 27 | 21   | 34 | 4 | 39   | 36   | 4.3 | 5.5 | 43   | 28 | 17.5 | 50 | G1/8 | 25.5 | 63   | 57   | 127  | 140 | 161 |