

Technical details

Temperature range	0°C ... +50°C
Input range	max. 16 bar
Mounting	arbitrary
Medium	compressed air filtered 5µm, oilfree
Materials	Body: zinc diecasting, seals: NBR and EPDM, inner parts: zinc coated steel, stainless steel and brass

Precision pressure regulator with diaphragm and relieving feature.



Order code

Series		Output range	
14 G1/4		B*	0.05 ... 2 bar
12 G1/2		C*	0.05 ... 4 bar
		D	0.05 ... 7 bar
		E**	0.05 ... 3 bar
		F**	0.05 ... 5 bar
		G**	0.05 ... 10 bar

* only for RP-14
** only for RP-12

RP-***-0-0001



Technical data

Model-no.:	RP-14-...	RP-12-...
Connection	G1/4	G1/2
Gauge connection	G1/8	G1/4
Flow (NI/min)	see diagram	see diagram
Internal air consumption	max. 4.1 l/min	max. 6 l/min
Weight (kg)	0.67	1.40

Flow characteristic

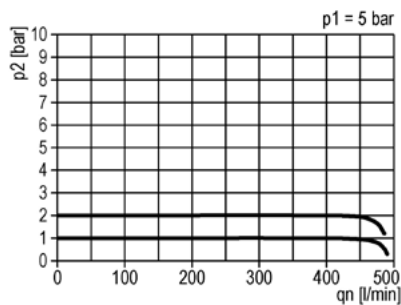
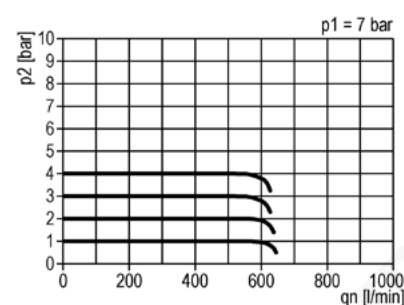
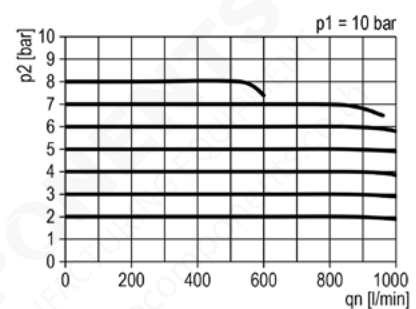
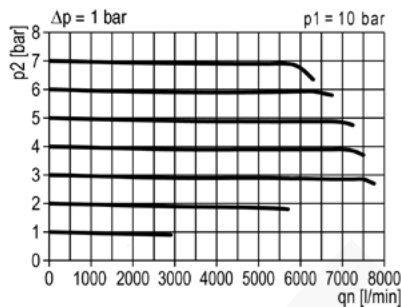
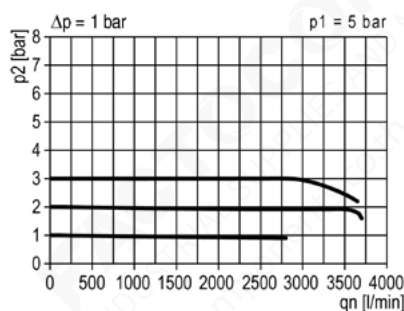
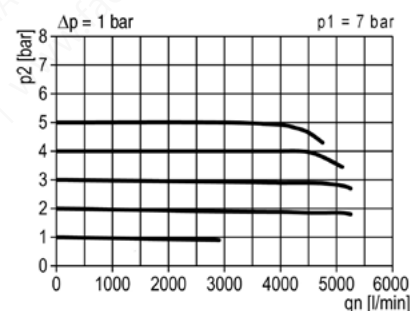
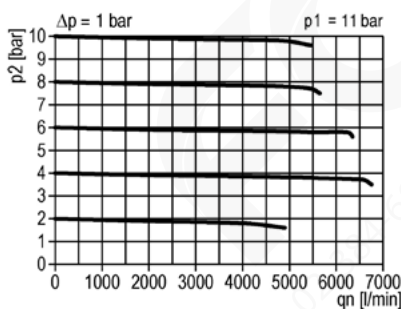
RP-14-B-...

RP-14-C-...

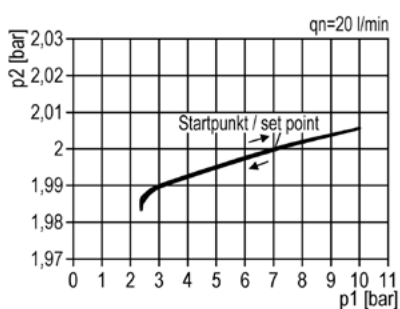
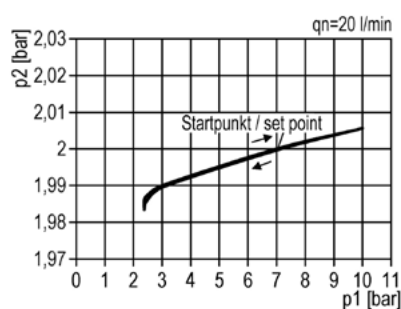
RP-14-D-...

RP-12-D-...

RP-12-E-...

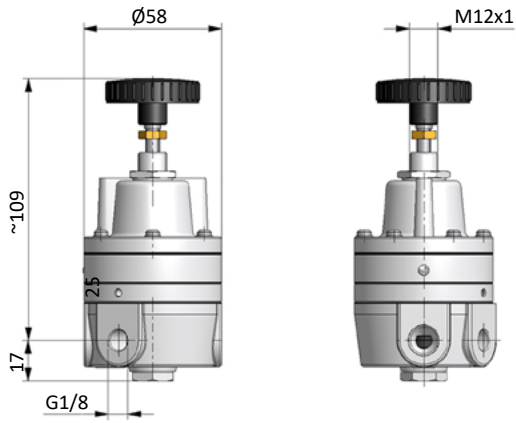
RP-12-F-...

RP-12-G-...

Hysteresis

RP-14-...

RP-12-...

Dimensions

RP-14



RP-12

